

# PRODUCT DATA

COMPACT P - SERIES BY NILAN



Domestic



Passive heat recovery



Active heat recovery



Ventilation < 300 m<sup>3</sup>/h



Comfort heating



Comfort cooling



Sanitary hot water production



Heating

# THE VENTILATION AND HEATING SOLUTION OF THE FUTURE

Compact P is developed for future homes. The system can be used in all types of low-energy and passive buildings, but can also ensure low energy consumption in any home or flat.

## Top-class efficiency

Compact P is equipped with the latest technology, comprising a highly-efficient counterflow heat exchanger, as well as a special designed heating pump that utilises the residual energy in the extracted air.

Overall, the system yields top-class performance. The counter flow heat exchanger has a temperature efficiency of up to 95%, combined with a heat pump that ensures a high supply air temperature and very low costs to production of sanitary hot water.

The integrated AIR 9, GEO 3, GEO 6 and GEO 9 heat pumps utilise the latest compressor technology to ensure that the heat output is continuously matched to the home's requirements.

## Many benefits

The compact design and numerous functions combined in one unit ensures minimum installation, space requirements, as well as rapid and easy installation. The latest technology and high-quality components not only provide an optimum indoor climate, but also low annual operating costs, making this a sound investment in every respect.



# ONE UNIT - SEVERAL SOLUTIONS

Since Compact P is module-based, it offers not just one, but several solutions. The unit can be combined with a geothermal or an outdoor air heat pump that can be fully integrated into Compact P. As either a supplementary or total heating solution, Compact P combines up to five functions:

- Ventilation with active and passive heat recovery
- Comfort heating
- Comfort cooling
- Sanitary hot water production
- Heating of the home (with AIR 9 or GEO 3/6/9)

## Compact P

- Ventilation with heat recovery
- Sanitary hot water production

Compact P can ventilate up to 300 m<sup>3</sup>/h and recovers more than 100 % of the energy from the extracted air via a counter flow heat exchanger that is combined with a heat pump.

The heat pump produces hot water and contributes to heating the supply air.

The heat pump has a reversible cooling circuit, so that in the summer it can cool the intake air while it also producing hot water.

*Compact PEK has a built in electrical kettle to heat the home via the central heating system.*



## Compact P AIR 9

- Ventilation with heat recovery
- Sanitary hot water production
- Space heating via an air/water heat pump

Besides ventilating the home and producing hot water, Compact P AIR 9 can also heat the home via underfloor heating or low-energy radiators.

AIR 9 is an air/water heat pump with a high heat output and a low energy consumption.



## Compact P GEO 3/6/9

- Ventilation with heat recovery
- Sanitary hot water production
- Space heating via a geothermal/water heat pump

Besides ventilating the home and producing hot water, Compact P GEO 3/6/9 can also heat the home via under floor heating or low-energy radiators.

GEO 3, GEO 6 and GEO 9 are geothermal heat pumps that both have a high output and low energy consumption compared to their sizes.



# COMPACT P

## Product description

Compact P is an energy-efficient total indoor climate solution for all types of low-energy buildings, single-family homes, flats and small office areas in commercial leases with a ventilation requirement of up to 300 m<sup>3</sup>/h.

Compact P recovers the energy from the extracted air using a highly efficient counter flow heat exchanger. The remaining energy that is not utilised by the counter flow heat exchanger is used by the heat pump to produce hot water, and to further heat the supply air.

The heat pump has a reversible cooling circuit, which means that, in the summer, the unit can cool the supply air by up to 10 °C. Due to the low air exchange, the cooling does not function as an air conditioning system. On cooling, the supply air is dehumidified, which gives a more pleasant indoor climate than is possible with an ordinary ventilation unit without a heat pump.



## Future-proof system

Compact P hot water production fulfils the most stringent requirements in the ecodesign regulation and thereby achieves the highest energy labelling.

The system is tested by an independent testing institute and has achieved the demanding Passive Building Certificate, as further confirmation that this is a highly energy-sustainable solution.

The Compact P series, with both GEO and AIR heat pumps, has achieved the German Smart Grid certification which means it can fit the operation to the power capacity of the power network.

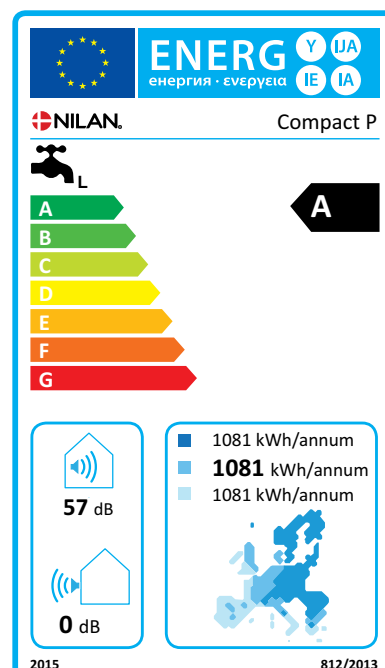

Time-controlled filter change alarm.  
Easy filter access by opening the top front panel with the help of two finger screws.

There is plenty of space to replace filters and to vacuum clean the filter space.

Intelligent humidity control.  
Adapts ventilation to the home's current humidity level.

CO<sub>2</sub>-sensor can be purchased, for further demand management.

A clear, user-friendly Touch panel is included.  
The modern CTS 700 control runs Modbus communication.



Low-energy EC-ventilators with B-wheel, adjustable from 20 to 100%.



Heating pump with hermetically sealed cooling circuit, for production of hot water and active heat recovery. Can raise the air intake temperature up to 34 °C.

Reversible cooling circuit that can also cool the air intake in the summer up to 10 °C, with simultaneous hot water production.

The LAN cable is led down, so that the control can be easily accessed without using tools.

Electrically monitored sacrificial anode and corrosion protection.

On any need for replacement, an alarm is activated in the operating panel.

180 l hot water tank.  
2 layers of glass enamelling to ensure a long lifetime.

Attractive white-painted front with large front panels, giving easy access to service the system.

The cabinet has holes for pipes and tubes for water and heating installations.

Counterflow heat exchanger in polystyrene, with a temperature efficiency ratio of up to 94%.

Automatic bypass function that carries the air past the counterflow heat exchanger when heat recovery is not required.

A powder-coated condensation tray prevents the formation of "acid water", leading out the condensation water.

Compact P has an integrated water lock.

1.5 kW electrical completion.  
For high hot water consumption where the heating pump cannot cope.

The hot water tank is foam-insulated, giving good insulation and saving energy.

Automatic anti-legionella.



Compact P is also offered in a Polar version with a built-in preheating element to frost proof the counterflow heat exchanger and heat pump.

# TECHNICAL DATA

## Technical specifications

Dimensions (W x D x H)	900 x 610 x 2065 mm
Weight	202 kg
Plate type casing	Aluzinc steel plate, white powder coating RAL9016
Heat exchanger type	Polystyrene counterflow heat exchanger
Fan type	EC, constant rotation
Filter class	ISO Coarse >90% (G4)
Duct connections	Ø 160 mm
Condensate drain	PVC, Ø 20x1,5 mm
Refrigerant	R134a
Refrigerant filling	2 kg
Capacity SHW tank	180 L
Supplementary electrical heating (sanitary hot water)	1,5 kW
Connection dimension	3/4"

Supply voltage	230 V (±10 %), 50/60 HZ
Max. input/power (*1)	2,2 kW/ 9,6 A
Max. input/power (*2)	3,4 kW/14,8 A
Tightness class	IP31
Standby power	3 W
Ambient temperature	-20/+40 °C
Power consumption build-in preheating element (Polar)	1,2 kW
External leakage (*3)	< 1,4%
Internal leakage (*4)	< 1,1%

\*1 Input without heating element (accessory).

\*2 Input Compact Polar

\*3 At ± 250 Pa and 265 m³/h according EN 308/EN 13141-7.

\*4 At ± 100 Pa and 265 m³/h according EN 308/EN 13141-7.

## Hot water production

Consumer profile, water heater	L (large)
Energy efficiency class	A
Energy efficiency for water heating - average climate	94 %
Annual electricity consumption - average climate	1081 kWh/annum
Temperature settings on the thermostat	10 - 65 °C
Sound power level L <sub>WA</sub>	57 dB(A)
The water heater can function outside peak load periods (Smart-grid)	No
Guidelines for assembly, installation and maintenance	See installation instructions
Energy efficiency for water heating - cold climate	94%
Energy efficiency for water heating - warm climate	94%
Annual electricity production - cold climate	1081 kWh/annum
Annual electricity consumption - warm climate	1081 kWh/annum

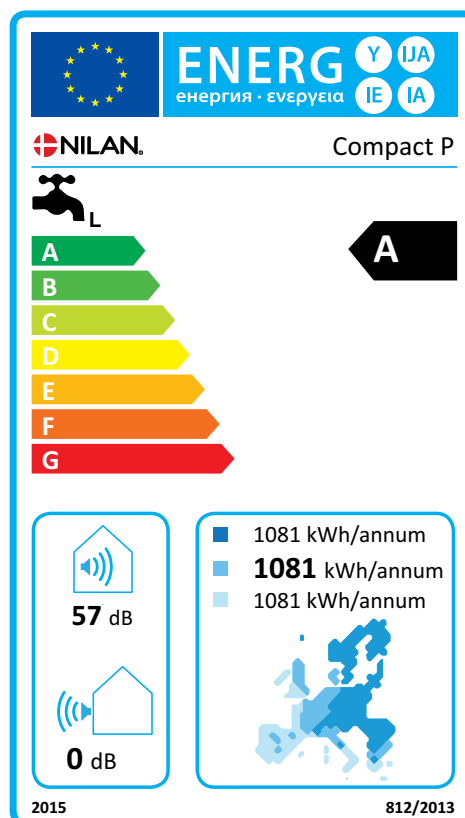

## Dimensional drawing

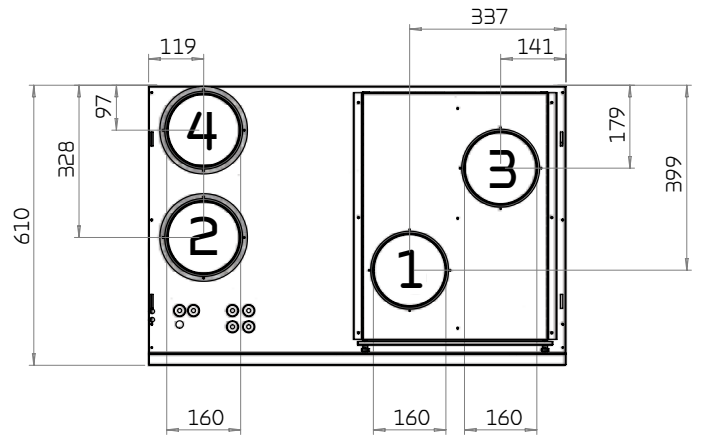
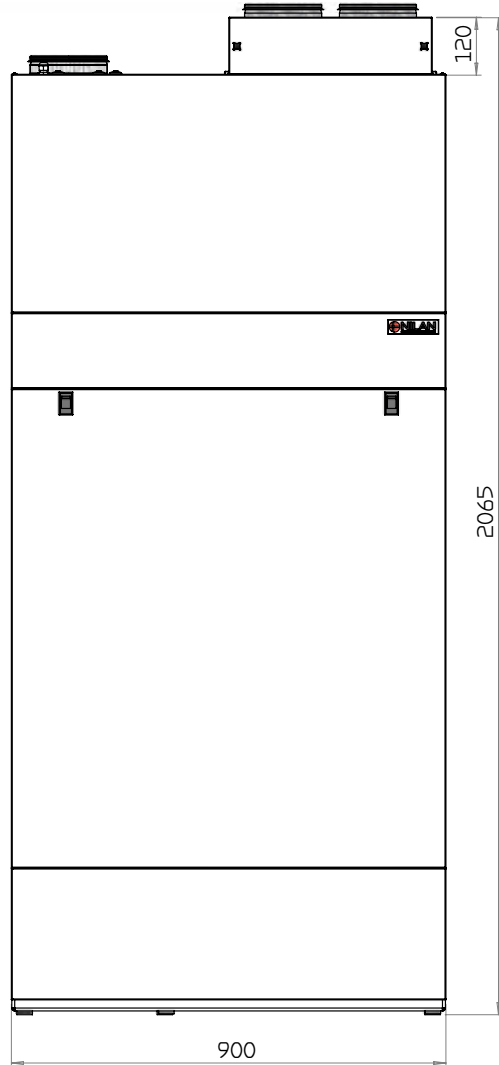

### Connections

- 1: Fresh air
- 2: Supply air
- 3: Extract air
- 4: Discharge air

# MULTI-FUNCTIONAL



## 100 % heat recovery

Compact P ventilates the home, ensuring a good indoor climate. While also producing hot water.

Compact P is an untraditional ventilation unit that, in contrast to other ventilation units, recovers 100% of the heat in the extracted air.

Via a counter flow heat exchanger, up to 95 % of the energy in the extracted air is used to heat the supply air.

The built-in heat pump uses the remaining energy to further heat the supply air, while also producing hot water.

### Cooling the home is the challenge of the future

New homes are well-insulated and therefore easy to heat. On the other hand, outdoor temperatures do not need to be very high before getting rid of the heat in the home becomes problematic.

Compact P has a reversible cooling circuit, to cool the supply air. Due to the low air exchange, it will not function as an air conditioning system. When cooling the supply air will be dehumidified, which contributing to a pleasant climate in the home.

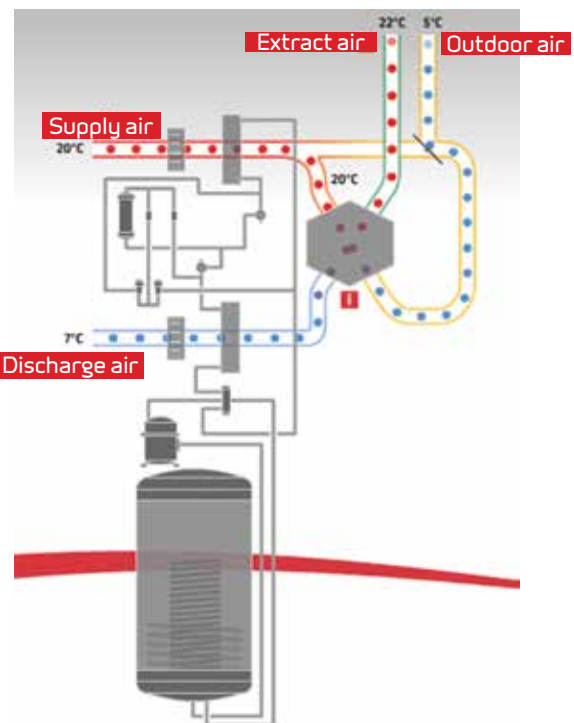

## Passive heat recovery

Passive heat recovery takes place via a counter flow heat exchanger with a high temperature efficiency, whereby the supply air is heated by the extracted air.



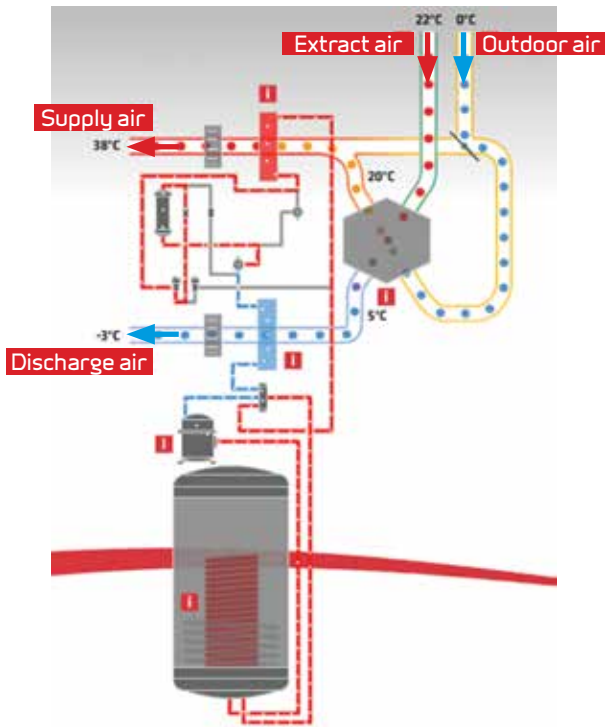

### Passive and active heat recovery

Utilising the residual energy that the counterflow heat exchanger does not use, the heat pump further heats the supply air.

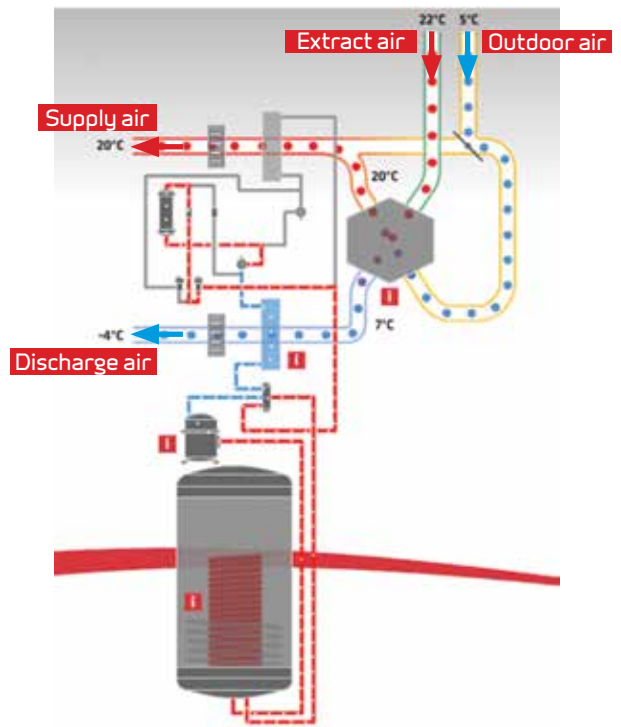

### Hot water

Utilising the residual energy that the counterflow heat exchanger does not use, the heat pump produces hot water.

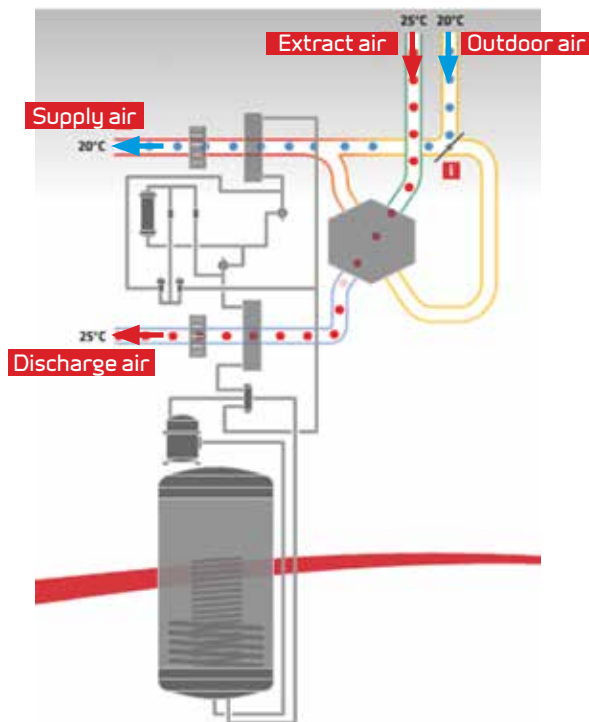

### 100% bypass function

If heat recovery is not required, the bypass damper closes off 100% and leads the outdoor air past the heat exchanger.

Hot water can be produced at the same time. Hot water is produced with a high efficiency (COP).

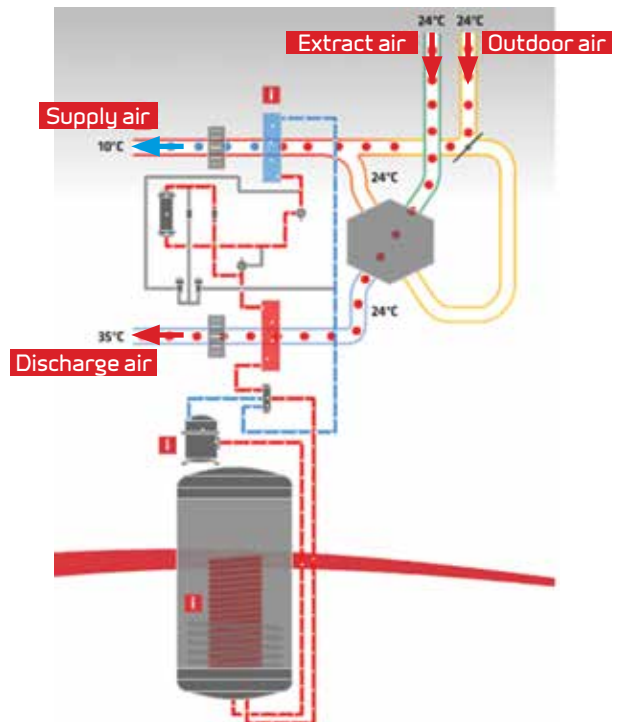

### Active cooling

The heat pump has a reversible cooling circuit and can cool the supply air during hot periods.

This function does not affect the production of hot water, which takes place with high efficiency (COP).

# PLANNING DATA

## Capacity

Capacity of standard unit as a function of  $q_v$  and  $P_{t,ext}$ .

SEL values according to EN 13141-7 are for standard units with ISO Coarse >90% (G4) filters and without heating element.

SEL values comprise the unit's total power consumption incl. control.

Conversion factor:  $\frac{J/m^3}{3600} = W/m^3/h$

**Attention!** The SEL values are measured and stated as a total value for both fans

*Compact P is also available in a XL-version, which can provide an air volume of 430 m<sup>3</sup>/h at 100 Pa*

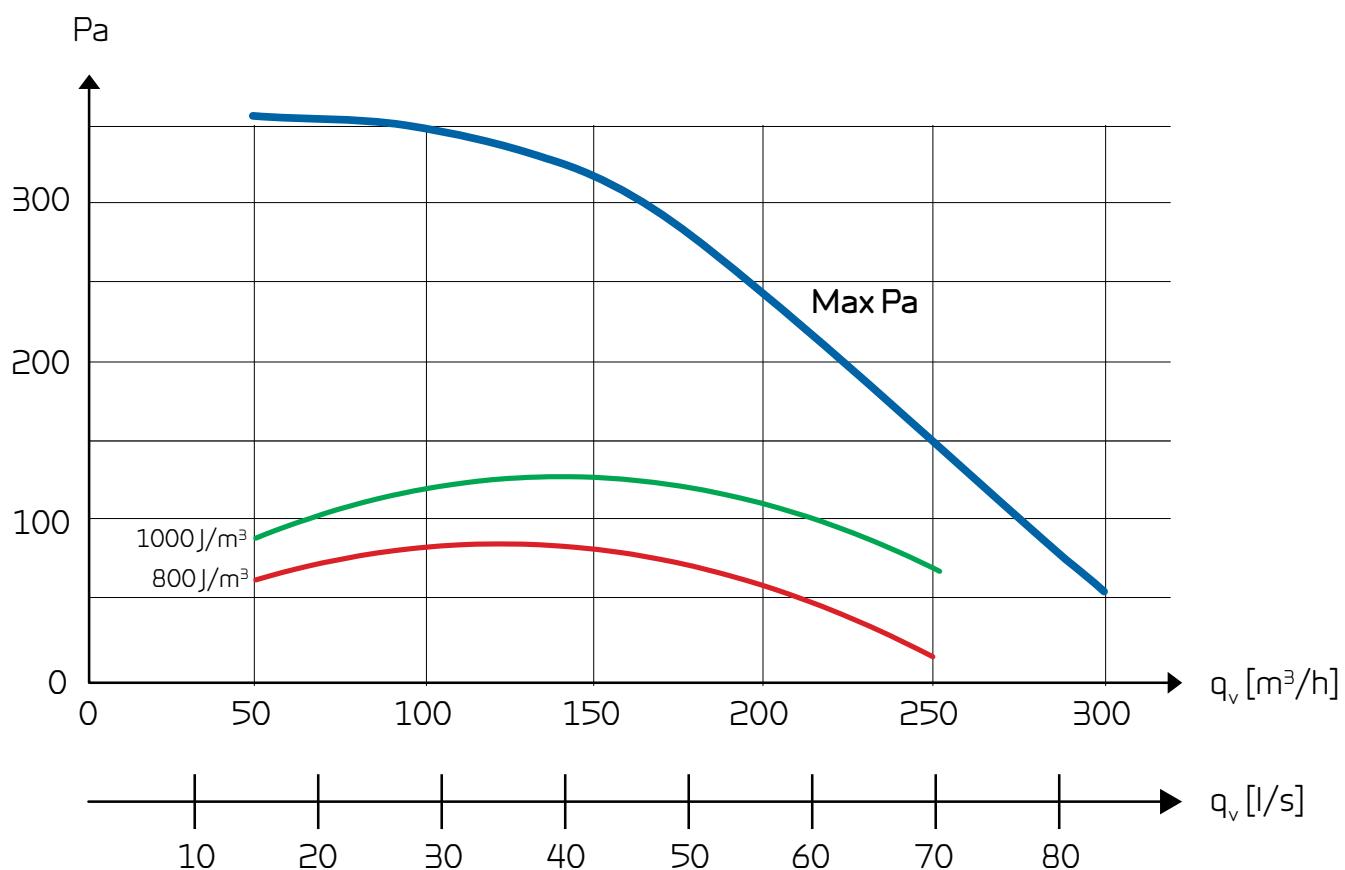

## Temperature efficiency

Temperature efficiency as a function of volume flow  $q_v$  [m<sup>3</sup>/h] for unit with counterflow heat exchanger.

Temperature efficiency according to EN13141-7 (2°C / 20°C).

*NB! The temperature efficiency, is for the heat exchanger only (without heat pump operation).*

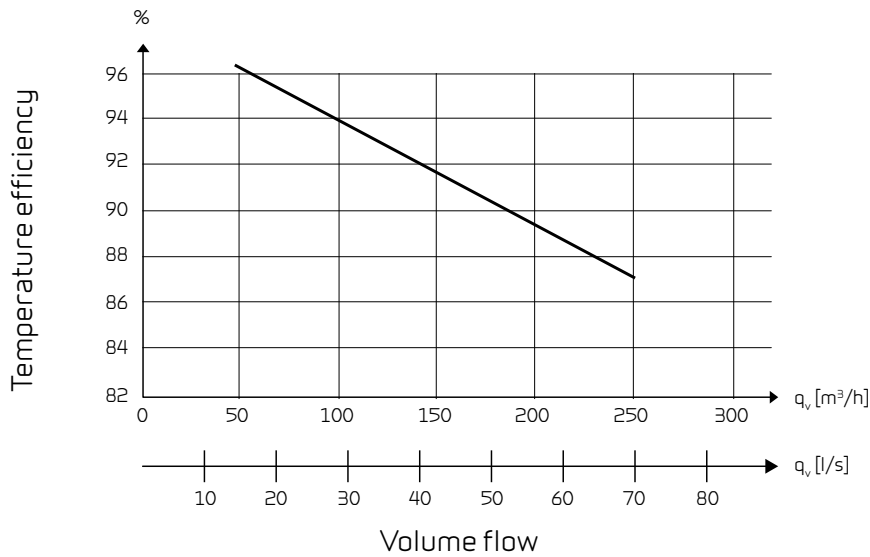

## Heat output supply air

Heat output  $Q_c$  [W] as a function of  $q_v$  [m<sup>3</sup>/h] and outdoor air temperature  $t_{21}$  [°C]. In accordance with EN 14511,  $t_{11}=21^\circ\text{C}$  (extract air)

Heat output is the contribution to room heating added to the fresh air via Compact P to the supply air.

The ventilation loss is the heat output that is lost without heat recovery at the given volume flow air.

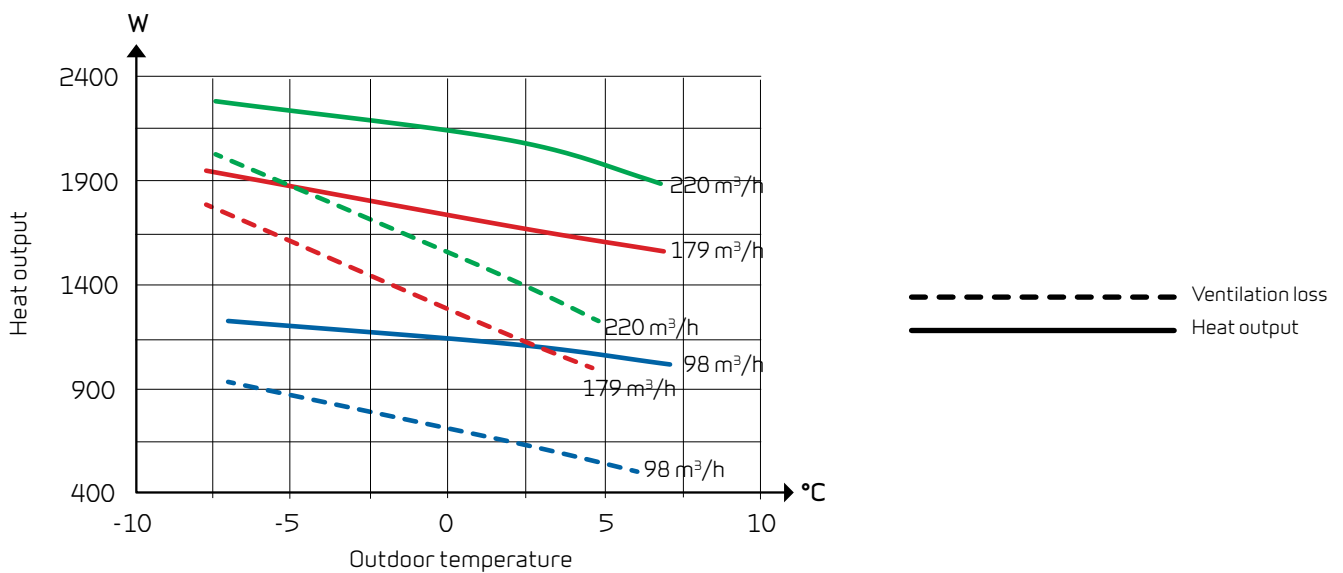

# PLANNING DATA

## Tapped water

Tapped volume in litres  $V_{max}$  [L] from Compact P tank as a function of tapped temperature  $t$  [°C] and tank temperature at 40°, 50° and 60°C

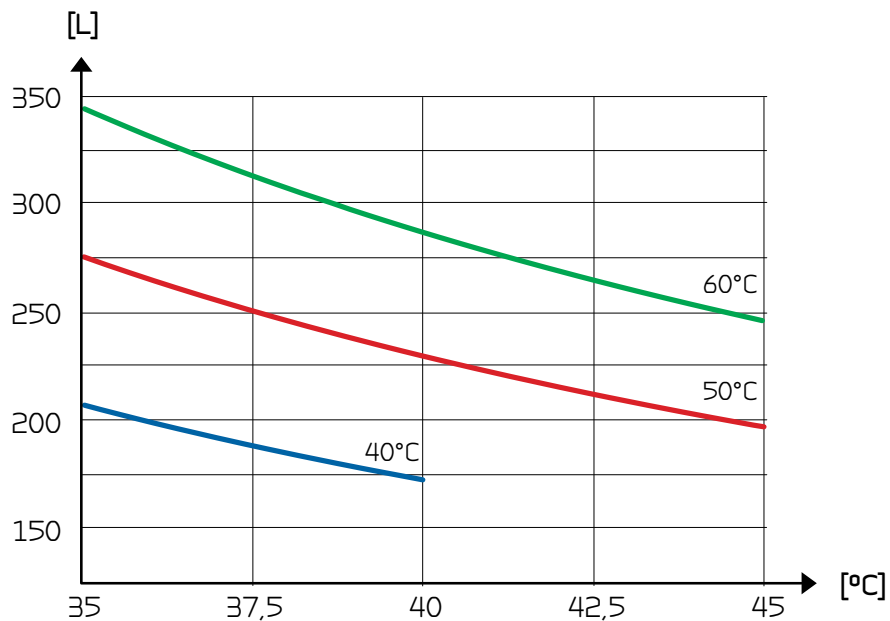

## COP (air-air)

Heat output factor COP [-] supply air as a function of outdoor temperature  $t_{21}$  [°C] and volume flow  $q_v$  [m<sup>3</sup>/h] in accordance with EN14511 at a room temperature  $t_{11} = 21$ °C

COP according EN14511 is calculated for the heat pump and counter flow heat exchanger combined.

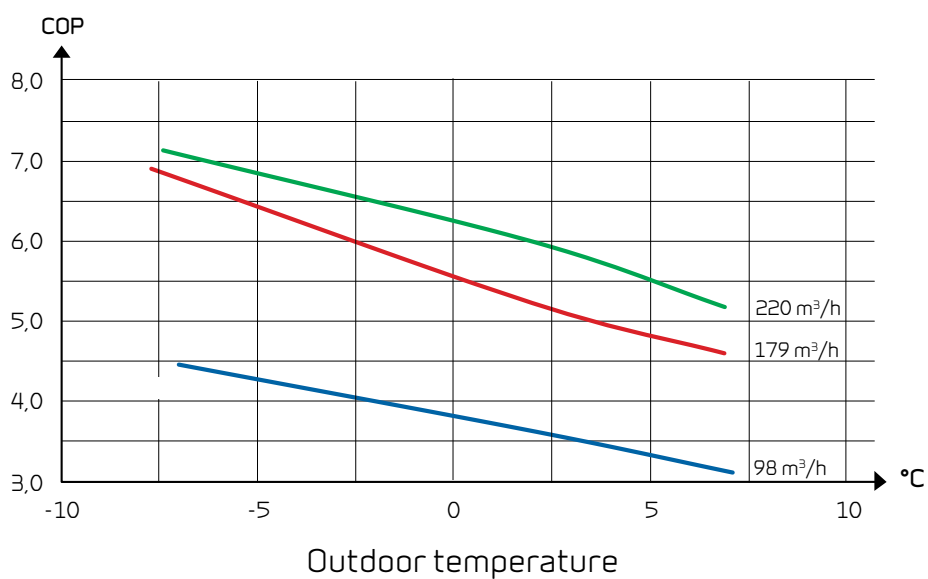

## Sound data

Sound data is for  $q_v = 210 \text{ m}^3/\text{h}$  and  $P_{t, \text{ext}} = 100 \text{ Pa}$  in accordance with EN 9614-2 for surface and EN 5136 for ducts.

Sound output level  $L_{\text{WA}}$  drops with falling air volumes and falling back-pressure.

At a given distance, the sound pressure level  $L_{\text{pA}}$  will depend on the acoustic conditions at the installation site.

### Sound output level ( $L_{\text{WA}}$ )

Octave band Hz	Surface dB(A)	Supply air dB(A)	Extract air dB(A)
63	-	51	38
125	-	59	46
250	-	66	51
500	-	61	41
1.000	-	56	31
2.000	-	54	28
4.000	-	47	20
8.000	-	40	13
Total $\pm 2$	57	69	53

# TECHNICAL DATA XL

## Compact P XL

Dimensions (W x D x H)	900 x 610 x 2065 mm
Weight	202 kg
Plate type casing	Aluzinc steel plate, white powder coating RAL9016
Heat exchanger type	Polystyrene counterflow heat exchanger
Fan type	EC, constant rotation
Filter class	ISO Coarse >90% (G4)
Duct connections	Ø 160 mm
Condensate drain	PVC, Ø 20x1,5 mm
Refrigerant	R134a
Refrigerant filling	2 kg
Capacity SHW tank	180 L
Supplementary electrical heating (sanitary hot water)	1,5 kW
Connection dimension	3/4"

Supply voltage	230 V (±10 %), 50/60 HZ
Max. input/power (*1)	2,4 kW/ 10,4 A
Max. input/power (*2)	3,6 kW/15,6 A
Tightness class	IP31
Standby power	3 W
Ambient temperature	-20/+40 °C
Power consumption build-in preheating element (Polar)	1,2 kW
External leakage (*3)	< 1,4%
Internal leakage (*4)	< 1,1%

\*1 Input without heating element (accessory).

\*2 Input Compact Polar

\*3 At ± 250 Pa and 265 m³/h according EN 13141-7.

\*4 At ± 100 Pa and 265 m³/h according EN 13141-7.

## Hot water production

Consumer profile, water heater	L (large)
Energy efficiency class	A
Energy efficiency for water heating - average climate	94 %
Annual electricity consumption - average climate	1081 kWh/annum
Temperature settings on the thermostat	10 - 65 °C
Sound power level L <sub>WA</sub>	57 dB(A)
The water heater can function outside peak load periods (Smart-grid)	No
Guidelines for assembly, installation and maintenance	See installation instructions
Energy efficiency for water heating - cold climate	94%
Energy efficiency for water heating - warm climate	94%
Annual electricity production - cold climate	1081 kWh/annum
Annual electricity consumption - warm climate	1081 kWh/annum

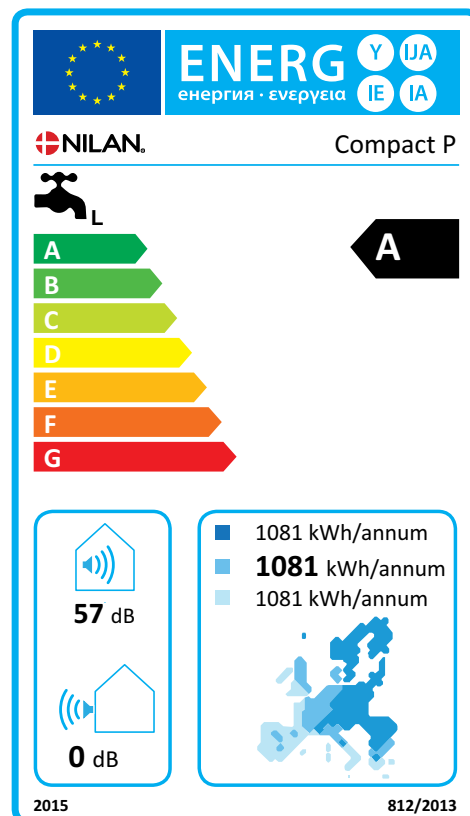

## Dimensional drawing

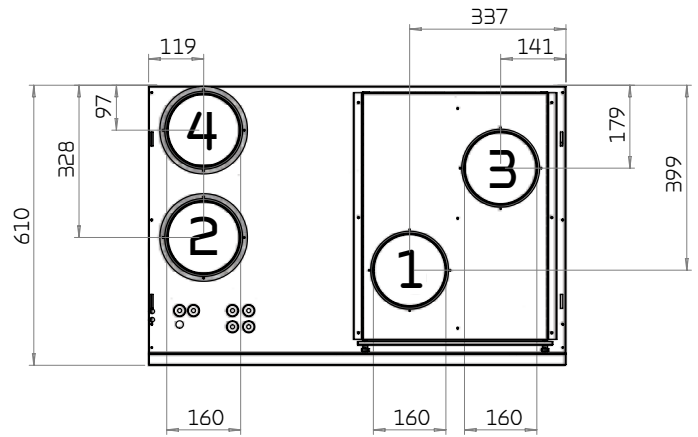
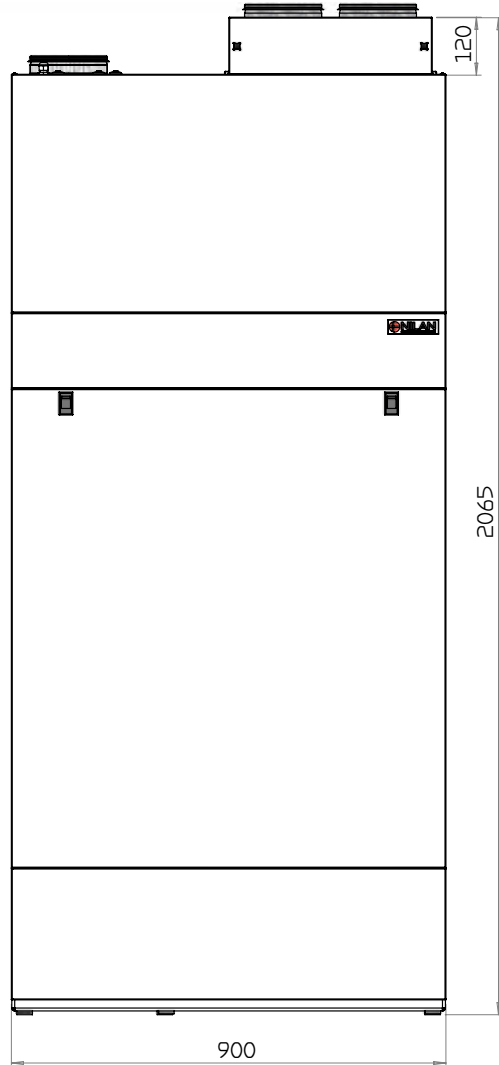

### Connections

- 1: Fresh air
- 2: Supply air
- 3: Extract air
- 4: Discharge air

# PLANNING DATA XL

## Capacity

Capacity of standard unit as a function of  $q_v$  and  $P_{t,ext}$ .

SEL values according to EN 13141-7 are for standard units with ISO Coarse >90% (G4) filters and without heating element.

SEL values comprise the unit's total power consumption incl. control.

$$\text{Conversion factor: } \frac{\text{J/m}^3}{3600} = \text{W/m}^3/\text{h}$$

**Attention! The SEL values are measured and stated as a total value for both fans.**

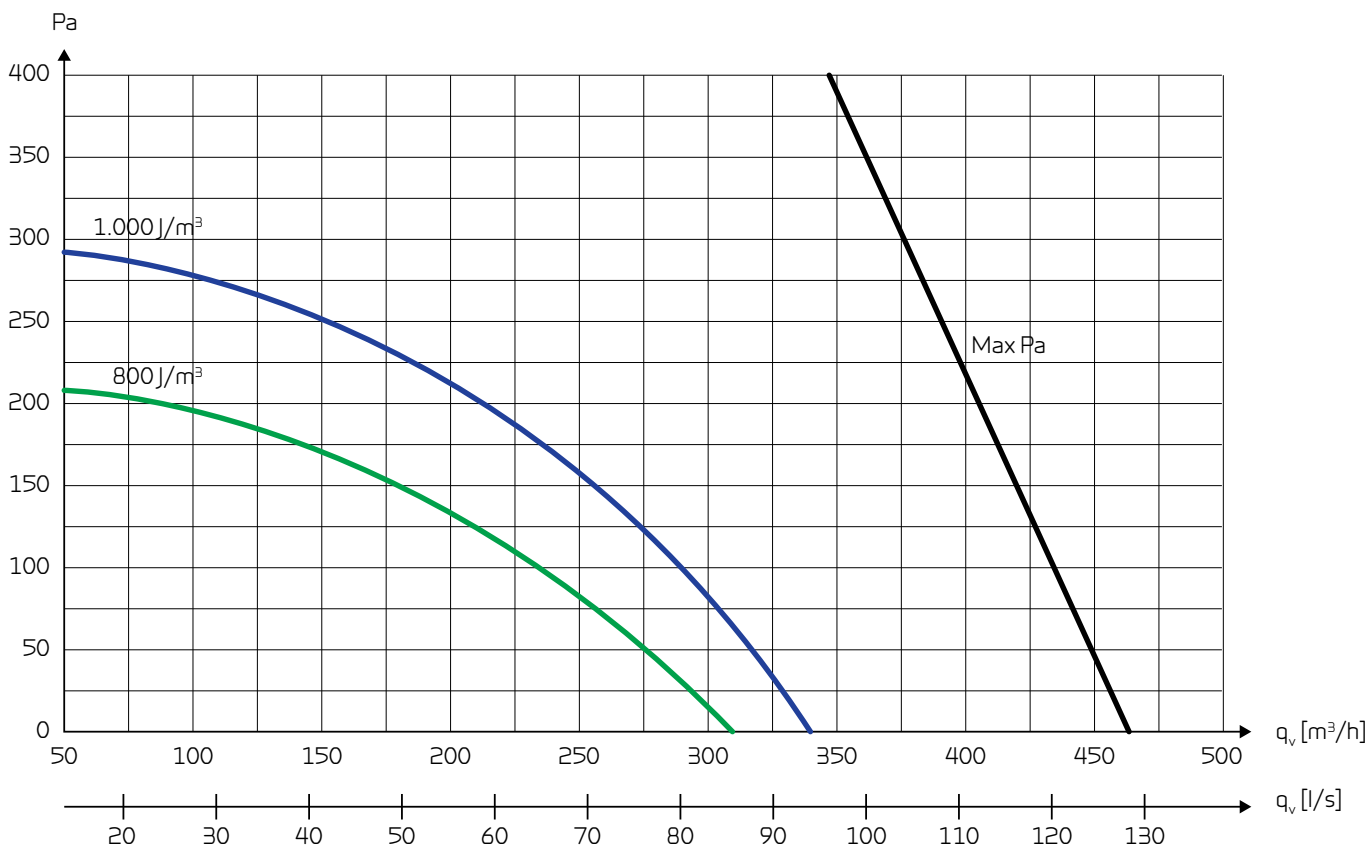



## Temperature efficiency

Temperature efficiency as a function of volume flow  $q_v$  [ $\text{m}^3/\text{h}$ ] for unit with counterflow heat exchanger.

Temperature efficiency according to EN13141-7 ( $2^\circ\text{C} / 20^\circ\text{C}$ ).

*NB! The temperature efficiency, is for the heat exchanger only (without heat pump operation).*

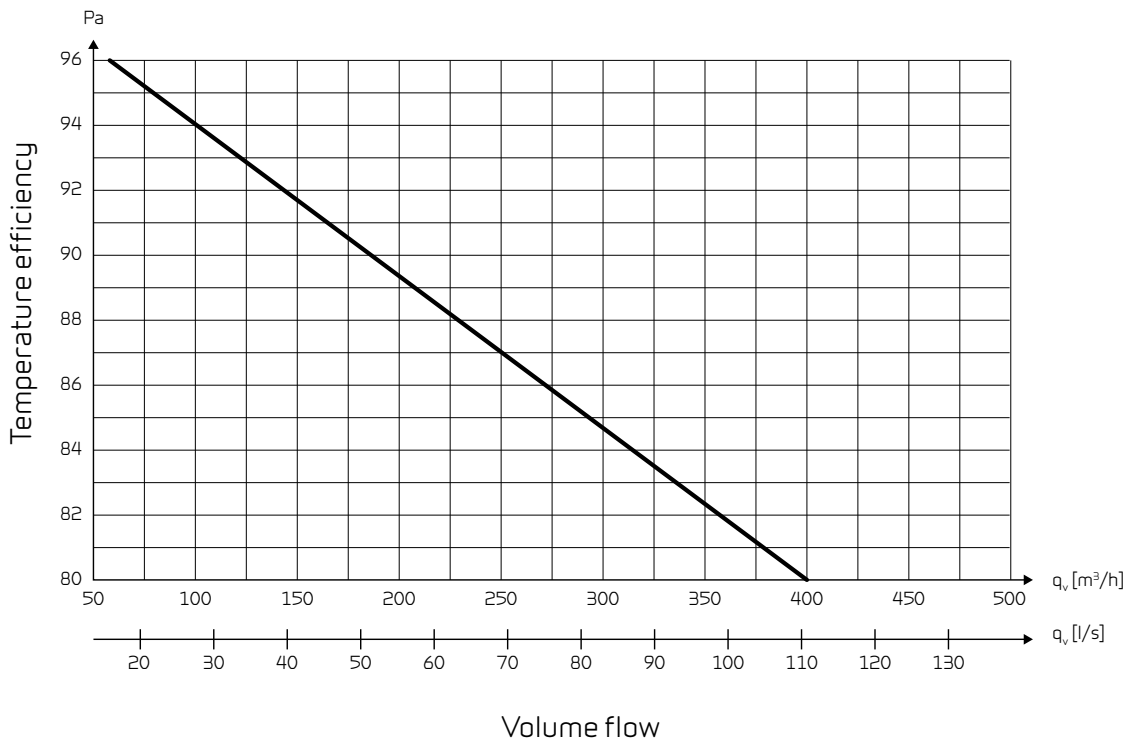

## Heat output supply air

Heat output  $Q_c$  [W] as a function of  $q_v$  [ $\text{m}^3/\text{h}$ ] and outdoor air temperature  $t_{21}$  [ $^\circ\text{C}$ ]. In accordance with EN 14511,  $t_{11}=21^\circ\text{C}$  (extract air)

Heat output is the contribution to room heating added to the fresh air via Compact P to the supply air.

The ventilation loss is the heat output that is lost without heat recovery at the given volume flow air.

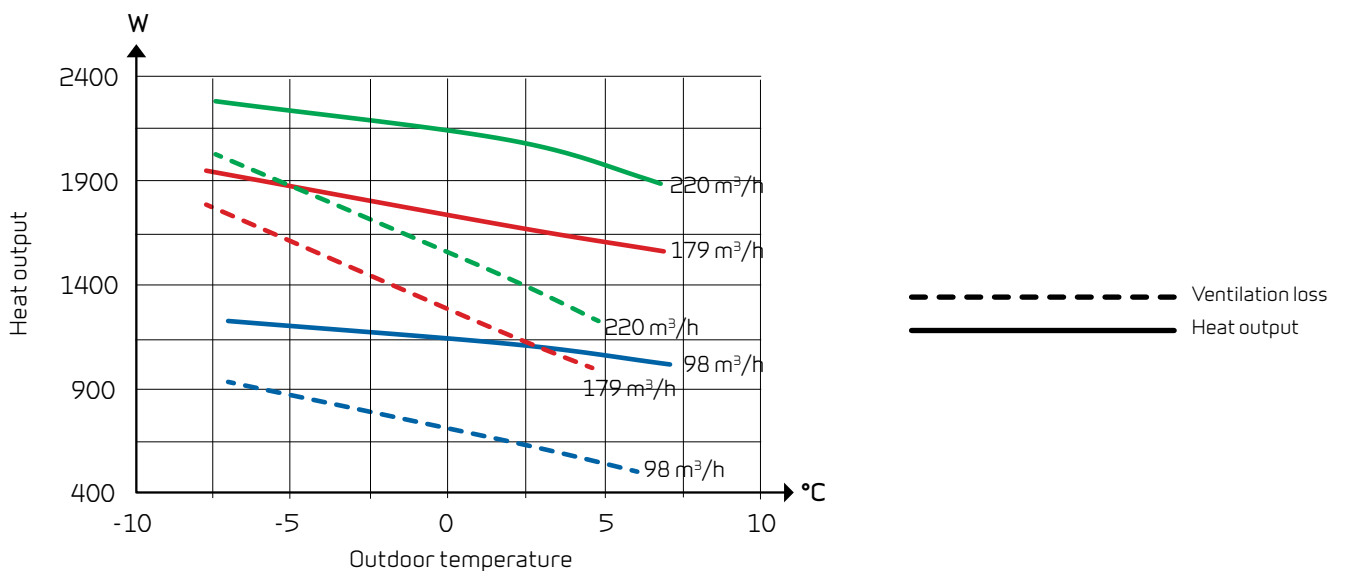

# PLANNING DATA XL

## Tapped water

Tapped volume in litres  $V_{max}$  [L] from Compact P tank as a function of tapped temperature  $t$  [°C] and tank temperature at 40°, 50° and 60°C

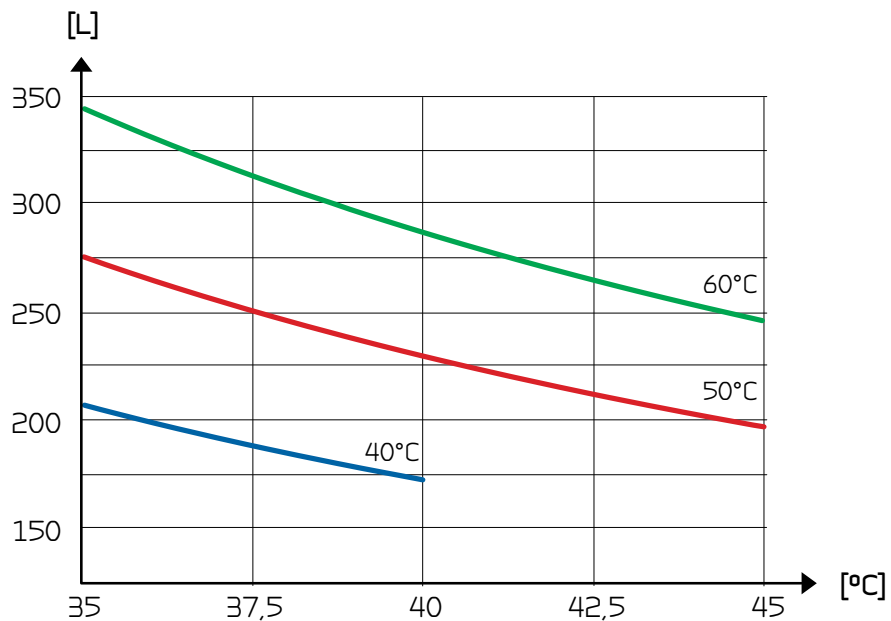

## COP (air-air)

Heat output factor COP [-] supply air as a function of outdoor temperature  $t_{21}$  [°C] and volume flow  $q_v$  [m³/h] in accordance with EN14511 at a room temperature  $t_{11} = 21$ °C

COP according EN14511 is calculated for the heat pump and counter flow heat exchanger combined.

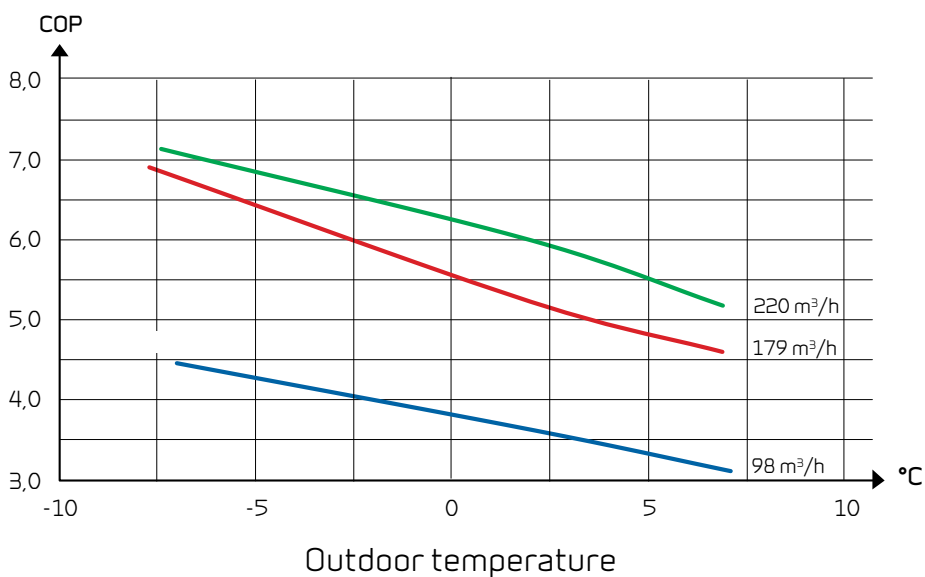

## Sound data

Sound data is for  $q_v = 210 \text{ m}^3/\text{h}$  and  $P_{t,\text{ext}} = 100 \text{ Pa}$  in accordance with EN 9614-2 for surface and EN 5136 for ducts.

Sound output level  $L_{\text{WA}}$  drops with falling air volumes and falling back-pressure.

At a given distance, the sound pressure level  $L_{\text{pA}}$  will depend on the acoustic conditions at the installation site.

### Sound output level ( $L_{\text{WA}}$ )

Octave band Hz	Surface dB(A)	Supply air dB(A)	Extract air dB(A)
63	-	51	38
125	-	59	46
250	-	66	51
500	-	61	41
1.000	-	56	31
2.000	-	54	28
4.000	-	47	20
8.000	-	40	13
Total $\pm 2$	57	69	53

# AUTOMATION

## CTS 700 Touch panel

The Compact P is controlled by its CTS 700 touch panel, which provides a wide range of functions, including menu-controlled operation, week programmes, time-controlled filter monitor, fan speed adjustment, temperature control, error messages etc.

The CTS 700's factory settings are default settings that can be adapted to operating needs and requirements, to achieve optimum operation and utilisation of the system.

Operating instructions for CTS 700 can be found in the separate user guide supplied with the system.



## Smart Grid function

Operating mode 1 - is lack of power. Therefore the GEO and AIR heat pumps will be turned off in those periods, typical up to 2 hours.

Operating mode 2 - is normal operation. The unit is running by the set values.

Operating mode 3 - is low cost power available. It is possible to use more power for e.g. hot water production by increasing the setpoint as well as increasing the supply temperature for the underfloor heating and use the floor as a buffer for the periods where the heat pump must be shut off.

Operating mode 4 - is overcapacity of power. It is possible to use more power for hot water production by increasing the setpoint but the GEO and AIR heat pumps must increase the supply temperature for the underfloor heating.



## Intelligent humidity control

Nilan's humidity control automatically adapts to the needs of the family or the building.

The intelligent CTS 700 control unit does not need to have a set level input for air humidity (RH) to control the air exchange. By using the integrated humidity sensor, the control unit calculates the average level itself for the last 24 hours. The average level provides a basis for deciding whether to change the air exchange if the air humidity fluctuates.

This ensures that the unit always runs at its most efficient, based on the actual air humidity level and not on a theoretical one.

This helps save energy because it automatically adapts to the requirements in the home. Whether a large family or a single person is living in the building has a considerable influence on how much humidity is produced.

The unit also adjusts automatically to summer and winter level.

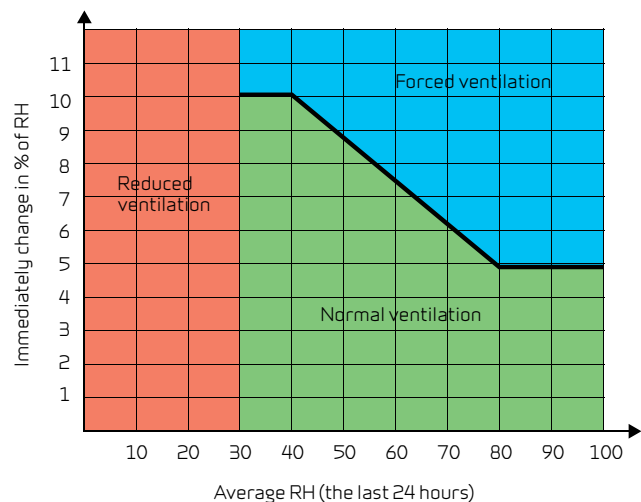

If the air humidity changes by more than 5-10% in relation to the average level, the unit responds with a higher rate of air exchange accordingly.

At an air humidity below 30% is reduced ventilation stp activated (adjustable between 15 and 45%)

Functional overview		+ Standard - Accessories
Smart Grid	The Smart Grid function regulates by four operating modes Operating mode 1: Lack of power Operating mode 2: Normal operation Operating mode 3: Low cost power Operating mode 4: Overcapacity of power	+
3 levels	The control function is divided into 3 levels: User/ Installer/ Factory with various options at each level.	+
Weekly plan	There is an option for you to set your own weekly programme.	+
User option 1	This allows you to override the operating mode in the main menu via an external potential-free contact or PIR sensor.	+
User option 2	This allows you to override the operating mode in the main menu via an external potential-free contact or PIR sensor. User option 2 has a higher priority than user option 1.	+
User option 2 out	When user option 2 is used, at the same time an output signal is given.	+
Alarms	The alarm list is featuring all alarms.	+
Datalog	Opportunity for datalog.	
Filter monitor	Filter monitor with timer (factory setting of 90 days). Adjustable to 30/90/180/360 days.	+
100% Bypass	Bypassing the outdoor air reduces heat recovery, enabling the desired supply air temperature to be maintained spring, summer and autumn.	+
Air quality	Allows you to choose whether to switch humidity sensors and/or CO <sub>2</sub> sensors on and off.	+/-
Humidity control	Allows you to set a higher or lower ventilation step in the case of high/low air humidity.	+
CO <sub>2</sub> control	Allows you to set a higher or lower ventilation step in the case of a high/low CO <sub>2</sub> level.	-
Air exchange	Allows you to select a low ventilation step in the case of low outside temperatures and air humidity.	+
Night setback	A possibility to set back the ventilation and temperature at night	+
Defrost function	Temperature-based automatic function for defrosting the heat exchanger.	+
Frostprotection	In case of failing heating system, the unit is turned off to avoid further cooling with a risk of the water heating coil frost bursting.	+
Temperature control	Allows you to select the temperature sensor which will control the unit. • TExt External room temperature sensor • T3 EXHAUST (extract air)	- +
Air volume	Allows you to set the ventilation flow stepless from 20 to 100 %. In 4 steps.	+
Summer/Winter operation	The unit automatically changes to summer or winter operation.	+
Legionella control	It is possible to choose a weekday or a day during the month, where the sanitary hot water temperature reaches 65 °C, for example between 1 and 6 o' clock.	
Fire alarm	This allows you to connect fire-detecting thermostats, smoke detectors and other fire alarm contacts. In case of an alarm, smoke dampers are closed and the unit stops.	+
Joint alarm	Outlet for joint alarm.	+
Cooling	Via bypass or heat pump. The heat pump has a reversible circuit, which means that the units circuit is reversed and the unit cools, rather than heating, the supply air. It is possible to choose whether the unit is to run a higher or highest ventilation stage during cooling. Via a weekly plan night cooling can be set up.	+
External heating element	• Temperature sensor T7 is an supply air sensor • Integrated frost protection for external water heating element • Motorised valve and circulation pump control unit	-
External electric heating element	• Temperature sensor T7 is an supply air sensor • Overheating protection	-
Delayed start-up	There is a possibility for a delayed start-up by the fans, when a closing damper is installed.	+
External network	It is possible to connect the unit to an external network.	+
Reset	Allows you to restore the factory settings.	+
Language	Option for setting the relevant language (Danish/German/English).	+

# COMMUNICATION

## Network communication

The CTS 700 control can be accessed via a PC application that is accessible for installation technicians.

The system can be connected directly to a PC, or connected via a local network and accessed via the network.

This makes it possible to remote control/control the system by connecting to the local network via the internet. It is recommended to create a fixed IP address for the network, in order to access the network without problems.

This makes it possible to offer the user a service contract, as the system can be monitored and controlled from any location, as long as there is an internet connection.



## Modbus communication

The CTS 700 control communicates as standard with Modbus TCP/IP communication. A CTS system using this form of communication can easily be connected to the unit.

Nilan units have an open Modbus communication, i.e. not only can the unit be monitored, but its operation can also be set in the same way as it can via the operating panel.

The protocol is set up by default for a Modbus TCP/IP.

IP-adress: 192.168.5.107 Port: 52 (adjustable)

A Modbus converter allows you to connect one or more units to a computer to monitor and control the units.

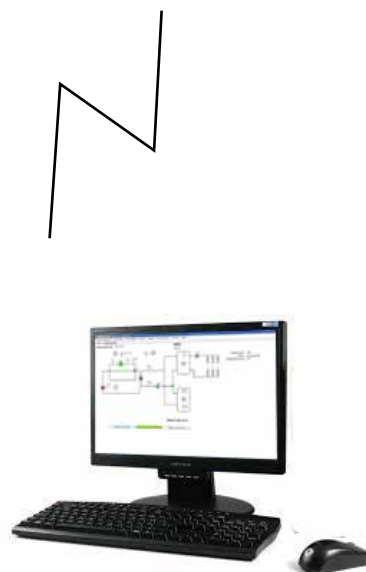

# CCDI-SYSTEM

All ventilation units with highly efficient heat recovery will ice up at extremely low outdoor temperatures.

The extracted air condenses when it is cooled during heat recovery. Due to the high temperature efficiency, the condensation will slowly be converted into ice, which will block the counter-flow heat exchanger, unless action is taken.

It must be considered whether the unit's balanced operation should be protected in continuing frosty conditions, and whether shorter periods of imbalance or a lower air volume can be accepted.

## Nilan standard de-icing

Compact P  
(without preheating element)

If Compact P without preheating element is selected, the unit will react to icing as described below.

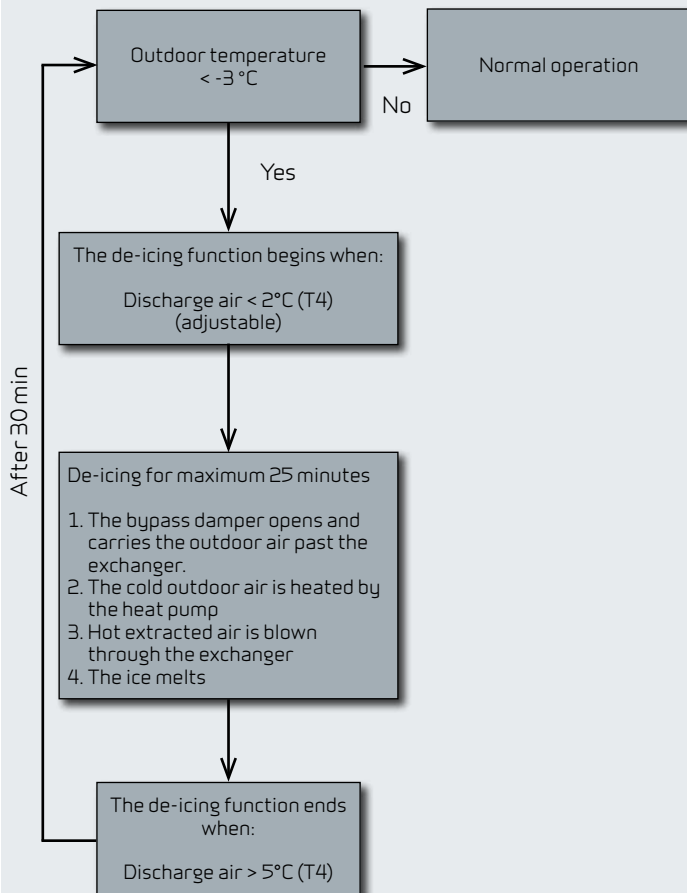

## Nilan CCDI-System (Condition Controlled De-ice System)

Compact Polar  
(with built-in pre-heating element)

If Compact Polar is selected, it is controlled by Nilan's unique CCDI (Condition Controlled De-ice) system. This is a very precise, energy-efficient way of ensuring continuous operation of the unit right down to -14°C.

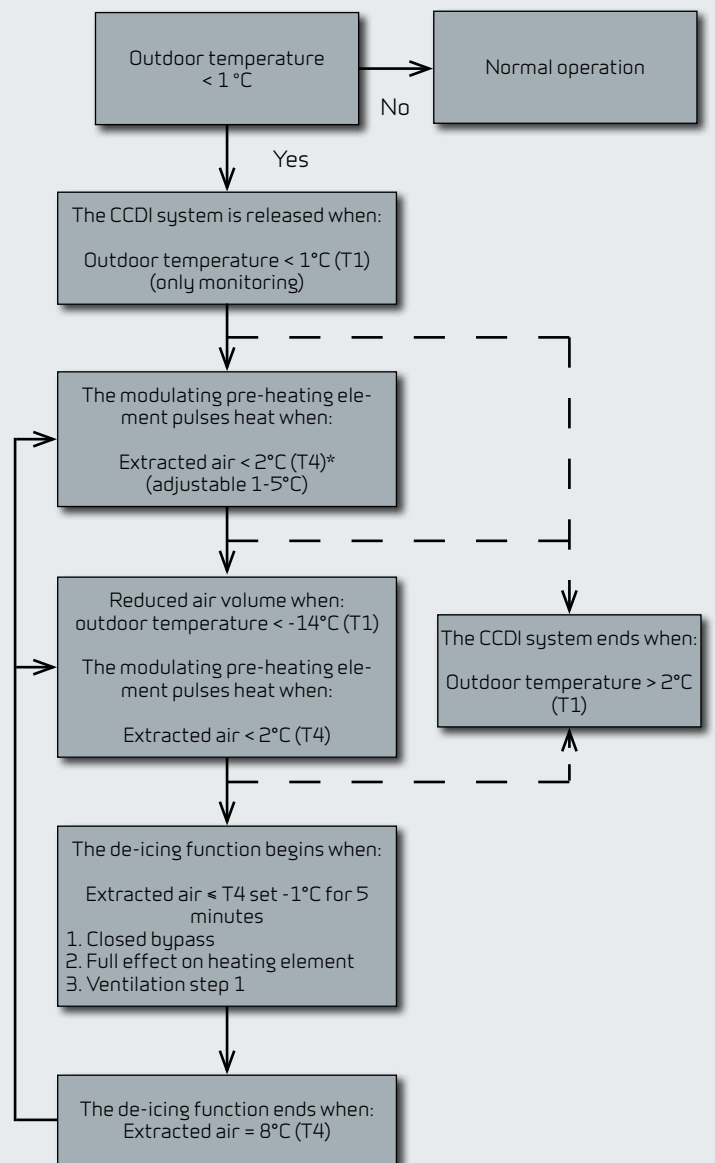

NB! All temperature settings are adjustable. On adjustment, they must be matched to the conditions in the home and the local climate.

# ACCESSORIES



## CO<sub>2</sub>-sensor

With a CO<sub>2</sub>-sensor installed, the ventilation speed can be pre-programmed with CTS 700 to run at a higher ventilation steps when CO<sub>2</sub> reaches high level in the extract air. CO<sub>2</sub>-level is programmable.



## Water heating element incl. regulation

The supply temperature can always be raised to the required level using a water heating element. The water heating element is designed to be built into the duct and must be connected to the primary heating supply. Supplied with two-way adjustment valve, temperature sensor and frost thermostat.



## Electrical heating surface incl. regulation

When you fit an electrical heating surface, you can raise the fresh air temperature to the desired level at any time. The electrical heating surface is supplied ready to fit into the fresh air duct and, for easy fitting, the device is pre-fitted with all the required sensors.



## Electrical pre-heating element (Frost protection)

An electrical pre-heating element heats up the outdoor air before it enters the unit. This avoids having to defrost the unit, resulting in a loss of power. There are temperature sensors supplied to be fitted in the ducts (Integrated in the Polar version)



## EM-box

An EM-box allows heat recovery from the air from the range hood and thereby helps to heat the supply air. The EM-box is equipped with a special filter which efficiently cleans the range hood air of fat particles and thereby protects the system.



## Pollen filter ISO ePM1 65-80% (F7)

A pollen filter class ISO ePM1 65-80% (F7) can be fitted in the unit. The pollen filter is fitted with the plate filter ISO Coarse >90% (G4).

## Top cover

To cover the ducting over the unit, Nilan offers a top cover in white-varnished aluminum (RAL 9016).

## Solar

Extra heat exchanger of 0.7 m<sup>2</sup> in the hot water tank, which can be connected to an approximately 3 m<sup>2</sup> solar heating system, or other heat sources.





# DELIVERY AND HANDLING

## Transport and storage

Compact P comes in factory packaging that protects it during transport and storage.

Compact P must be stored in a dry place in its original packaging until installation. The packaging should only be removed immediately prior to installation.

## Lifting cover

Lifting cover for Compact P makes it possible to lift Compact P off the pallet without making any heavy lifts and transport the system around in the home. Detach the filter box and the system fits under an average inner door.



## Installation conditions

During installation, future service and maintenance should be taken into account. We recommend a minimum gap in front of the unit of 60 cm.

The unit must be installed level for the sake of the condensate drain.

## Installation of electric heating element

Electric heating elements (accessories) are fitted in the duct. The heating element must be insulated using fire-resistant insulation material. The electric heating element must be connected by an authorised electrician.

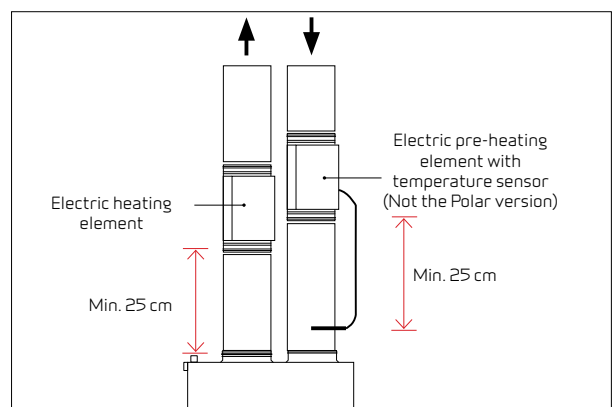

# COMPACT P AIR 9

## Product description

Compact P AIR 9 has the same benefits and functions as Compact P, but also has an integrated air/water heat pump, with connection to waterborne underfloor heating or low-temperature radiators for central heating.

The solution consists of an integrated interior section in Compact P, as well as an exterior section that is easy to connect.

AIR 9 is delivered with a reversible heat pump, which also makes the unit capable of cooling.

AIR 9 is very silent and can be placed without disturbing its surroundings. During summer, when only hot sanitary water is needed, the fan is limited, reducing the noise level. This limit occurs when the outdoor temperature exceeds 7 °C and limiting the compressors output to a maximum of 60 %. These criteria can be set individually.



## Inside unit for Compact P AIR 9

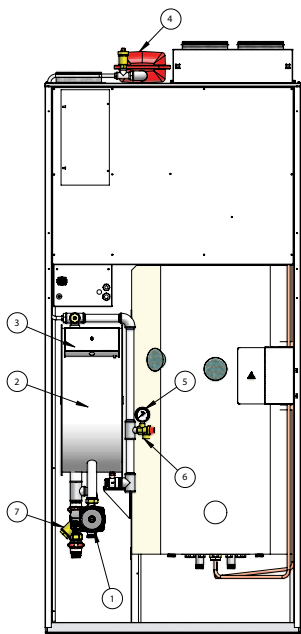

### Front

1. Integrated circulation pump interior/ exterior sections 1"
2. 50-litre buffer tank
3. 2 x 3 kW supplementary electrical heating
4. Pressure expansion vessel (central heating circuit)
5. Manometer (central heating circuit)
6. Safety valve, 2.5 bar (central heating circuit)
7. Particle filter

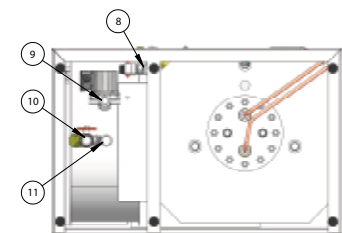

### Base

8. Flow, central heating 3/4"
9. Flow to exterior section 1"
10. Return flow from exterior 1"
11. Return flow from exterior 3/4"

## Outside unit for Compact P AIR 9

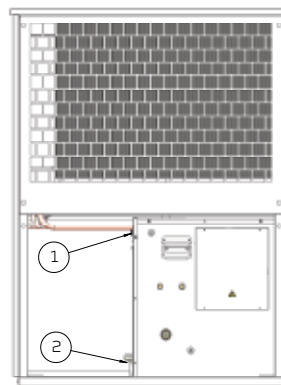
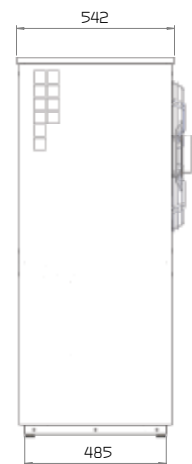
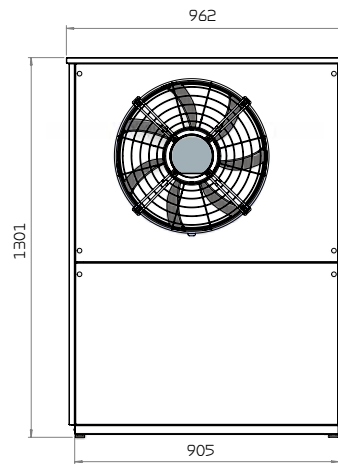

1. Flow 1"
2. Return flow 1"



Effective and quiet ventilator with "owl wings".

Summer/winter setting ensures an extra low sound level in the summer.

Low-energy EC-motor.

AIR 9 exterior unit is made from white powder-coated aluzinc steel plate (RAL 9016).

Powder-coated condensation tray prevents "acid water" and leads off the condensation.

A heating cable for frost protection of the condensation drain is included.



Adjustment screws for levelling

AIR 9 is controlled via the same CTS 700 touch panel as is used for Compact P.



A large, well-dimensioned evaporator ensures a good output.

AIR 9 is reliable right down to -22°C

An inverter-controlled DC compressor ensures a variable output and low energy consumption.

Hermetically-sealed cooling circuit.

The aggregate can therefore be installed without requiring a cooling technician.



AIR 9 interior unit is integrated in Compact P.

This saves space and ensures a neat and tidy installation.

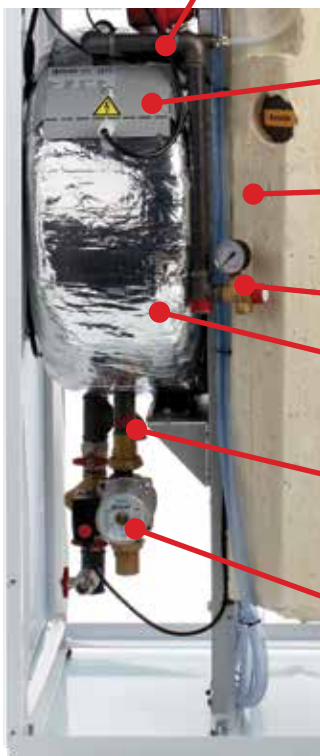

Supplementary electrical heating of 2 x 3 kW  
Ensures indoor heating during periods of severe frost.

8-litre expansion tank for central heating.  
Placed on top of the system.

Safety valve to the central heating system.

Manometer showing the current pressure in the central heating system.

50-litre buffer/charge circuit.  
The central heating can thus be activated as required.

Filling tank for central heating.

Soil filter.

Integrated circulation pump to AIR 9 (exterior unit).

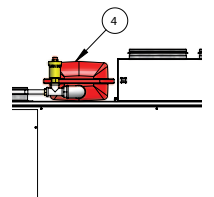

# TECHNICAL DATA

## Technical specifications

Dimensions (inside part) (W x D x H) - Integrated in Compact P	550 x 300 x 1100 mm
Weight (inside part)	55 kg
Control	CTS 700
Dimensions (outside part) (W x D x H)	962 x 542 x 1301 mm
Weight (outside part)	125 kg
Supply voltage (inside part)	400/230V 3L+N+PE, 50Hz
P <sub>MAX</sub> (inside part)	6.1 kW
Fuse size (inside part)	16 A
Standby electricity consumption	2.5 W
Supplementary electrical heating	2 x 3 kW
Buffer tank (integrated)	50 L
Design pressure (central heating)	4 bar
Opening pressure safety valve (central heating)	2.5 bar
Expansion vessel (central heating)	8 Litre
Booster expansion vessels	0.5 bar G
Max. air volume	3400 m <sup>3</sup> /h
Variable compressor	30 - 100 %
Tightness class fan	IP54
Supply voltage (outside part)	230V 1N+PE, 50Hz
P <sub>MAX</sub> (outside part)	3.3 kW
Fuse size (outside part)	16 A
Rated output, (max/min) A-Pump	31/99 W
Rated output, (max/min) A-Pump	0.2/0.63 A
Condenser pressure loss (central heating)	15 kPa/0.42 l/s
Central heating connection	3/4"
Refrigerant	R410A
Refrigerant filling	3.4 kg
Pressostat low pressure (on/off)	2.2/3.4 bar G
Pressostat high pressure (on/off)	4.2/3.3 bar G
Operating temperatures	-22 °C → 50 °C
Central heating, flow temperature	25 °C → 45 °C
Connection dimension	1"
Heat output P <sub>H</sub> with variable compressor at 7°C/35°C, according to EN 14511:2012 (max. 5400 RPM)	8.4 kW
Heat output P <sub>H</sub> with variable compressor at 2°C/35°C, according to EN 14511:2012 (max. 5400 RPM)	6.7 kW
Heat output P <sub>H</sub> with variable compressor at -7°C/35°C, according to EN 14511:2012 (max. 5400 RPM)	5.7 kW
Heat output P <sub>H</sub> with variable compressor at -15°C/35°C, according to EN 14511:2012 (max. 5400 RPM)	4.5 kW
Heat output P <sub>H</sub> with variable compressor at 7°C/45°C, according to EN 14511:2012 (max. 5400 RPM)	7.8 kW
Heat output P <sub>H</sub> with variable compressor at -7°C/45°C, according to EN 14511:2012 (max. 5400 RPM)	5.4 kW
SCOP testet according to EN 14825:2012*	5.11
P <sub>design</sub> (t <sub>out</sub> -10°C)	5.21 kW

\*SCOP (Seasonal COP) is for "low temperature use, average climate, defined flow, reversible"

## Sound

The sound from the AIR outside part reverberates depending on the placement around the house as well as the substrate on which the unit stands and the surroundings. The below is measured for hard substrate.

Sound effect L<sub>wa</sub> dB(A) 7/6 °C - 30/35 °C = 46 dB(A) according to EN14511, EN 12102, EN3743/1 - Ecodesign 811/2013 and 813/2013.

Sound pressure L<sub>pA</sub> dB(A) according to EN13487:2003

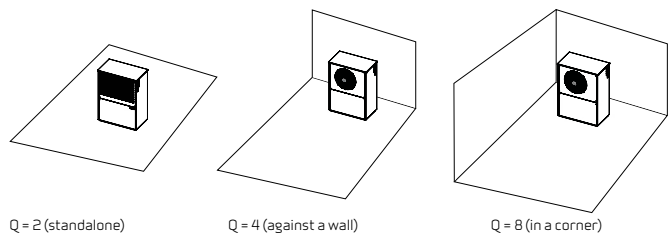

Distance in meters	1	2	6	10	21
Position factor 2	38	32	22	18	12
Position factor 4	41	35	26	21	15
Position factor 8	44	38	28	24	18

# Heat pump for space heating

Model	AIR 9
Air-to-water heat pump	Yes
Water-to-water heat pump	No
Brine-to-water heat pump	No
Low-temperature heat pump	Yes
Equipped with a supplementary heater	Yes
Heat pump combination heater	No
<b>Temperature control:</b>	
Model	CTS700
Class	2
Contribution to seasonal space heating energy efficiency	2%

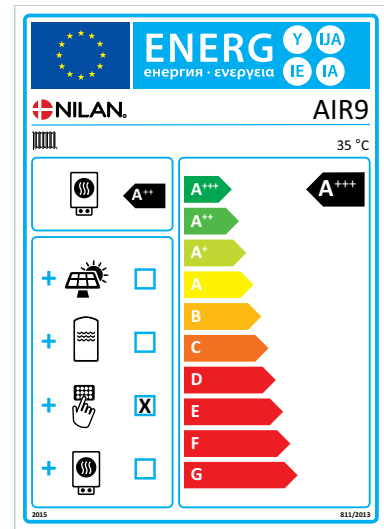

Item	Symbol	Value	Unit
------	--------	-------	------

Rated heat output	$P_{rated}$	5,21	kW
-------------------	-------------	------	----

Declared capacity for heating for part load at indoor temperature 20 °C and outdoor temperature of  $T_j$

$T_j = -7\text{ °C}$	$P_{dh}$	4,79	kW
$T_j = +2\text{ °C}$	$P_{dh}$	2,88	kW
$T_j = +7\text{ °C}$	$P_{dh}$	1,90	kW
$T_j = +12\text{ °C}$	$P_{dh}$	2,12	kW
$T_j = \text{bivalent temperature}$	$P_{dh}$	5,21	kW

$T_j = \text{operation limit temperature}$	$P_{dh}$	0	kW
For air-water-heating pumps $T_j = -15\text{ °C}$ (if TOL < -20 °C)	$P_{dh}$		kW
Bivalent temperature	$T_{biv}$	-10	°C
Cyclling interval capacity for heating	$P_{cyc}$		kW
Degradation co-efficient	$C_{dh}$	0,94-0,99	

### Power consumption in modes other than active mode

Off mode	$P_{OFF}$	0,01	kW
Thermostat off-mode	$P_{TO}$	0,005	kW
Standby mode	$P_{SB}$	0,01	kW
Crankcase heater mode	$P_{CK}$	0	kW

### Other items

Capacity control:	Variable compressor Variable indoor water flow		
	Variable indoor temperature adjustment		
Sound power level, outdoors	$L_{WA}$	46	dB
Emissions of nitrogen oxides	$Q_{NE}$	1464	kWh

Item	Symbol	Value	Unit
------	--------	-------	------

Seasonal space heating energy efficiency	$\eta_s$	206	%
--	----------	-----	---

Declared coefficient of performance or primary energy ratio for part load at indoor temperature 20 °C and outdoor temperature  $T_j$

$T_j = -7\text{ °C}$	$COP_d$	3,20	
$T_j = +2\text{ °C}$	$COP_d$	4,95	
$T_j = +7\text{ °C}$	$COP_d$	6,53	
$T_j = +12\text{ °C}$	$COP_d$	9,69	
$T_j = \text{bivalent temperature}$	$COP_d$	2,83	

$T_j = \text{operation limit temperature}$	$COP_d$	0	
For air-to-water heat pumps: $T_j = -15\text{ °C}$ (if TOL < -20 °C)	$COP_d$		
For air-to-water heat pumps: Operation limit temperature	TOL	-22	°C
Cyclling interval efficiency	$COP_{cyc}$		
Heating water operating limit temperature	WTOL	45	°C

### Supplementary heater

Rated heat output	$P_{sup}$	6	kW
Type of energy input	Electrical		

For air-to-water heat pumps: Rated air flow rate, outdoors		3000	m³/h
For water-/brine-water heat pumps: Rated brine or water flow rate, outdoor heat exchanger			m³/h

# INSTALLATION

## Compact P AIR 9

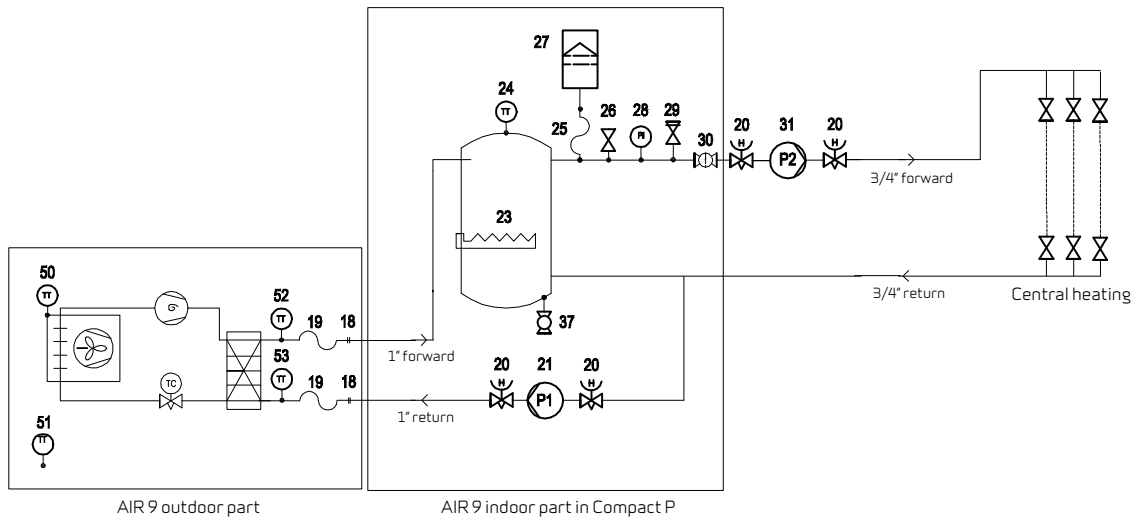

- |   |   |
|---|---|
| 18 Connection 1"                                | 28 Manometer                                  |
| 19 Flexihose 1"                                 | 29 Safety valve 2,5 bar                       |
| 20 Shut-off valve                               | 30 Shut-off valve with dirt filter            |
| 21 P1 circulation pump 130 mm                   | 31 P2 circulation pump                        |
| 23 Supplementary electrical heating 2 x 3 kW    | 37 Feed tap 1/2"                              |
| 24 Temperature sensor T18 buffer tank (forward) | 43 3-way valve                                |
| 25 Flexihose 10 mm                              | 50 Temperature sensor T23 evaporator          |
| 26 Automatic control vent 3/8"                  | 51 Temperature sensor T20 outdoor temperature |
| 27 Expansion tank 8 litre                       | 52 Temperature sensor T17 after condenser     |
|   | 53 Temperature sensor T16 before condenser    |

## SHW warmwater-tank connected to Compact P AIR 9

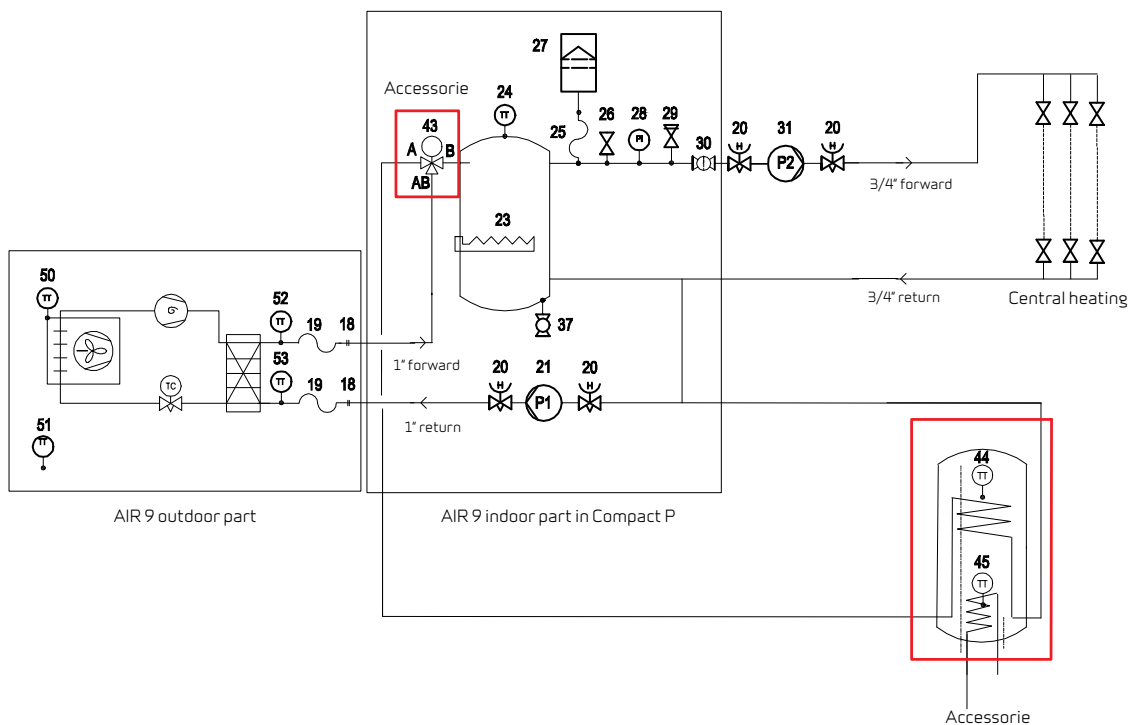

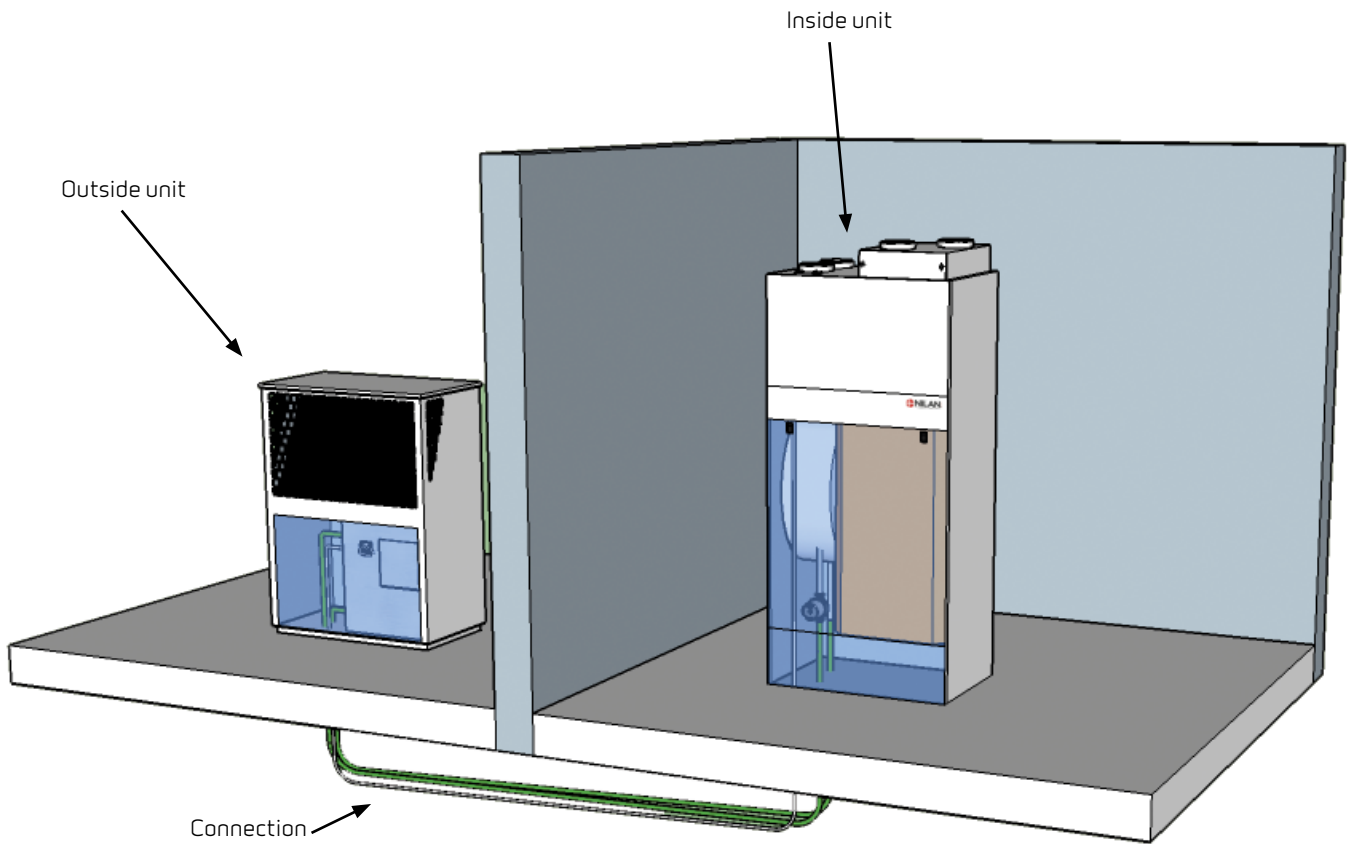

## Simple installation

AIR 9 is an outdoor air heat pump that is connected to the Compact P interior section via hydraulic tubes and a communication line.

The hermetically sealed heat pump is installed in the outside part, with reliable operation right down to  $-22\text{ }^{\circ}\text{C}$ .

A circulation pump is mounted on the inside part, to pump the boiler water between the outside and inside sections. The circulation pump is a low-energy pump.

There is an integrated frost protection cable to ensure that the condensation drain does not freeze.

The outside part is run by CTS700 automatic controls via the control panel used for the Compact P.

AIR 9 is placed on a stable base, e.g. a cast foundation, and towards the prevailing wind direction.

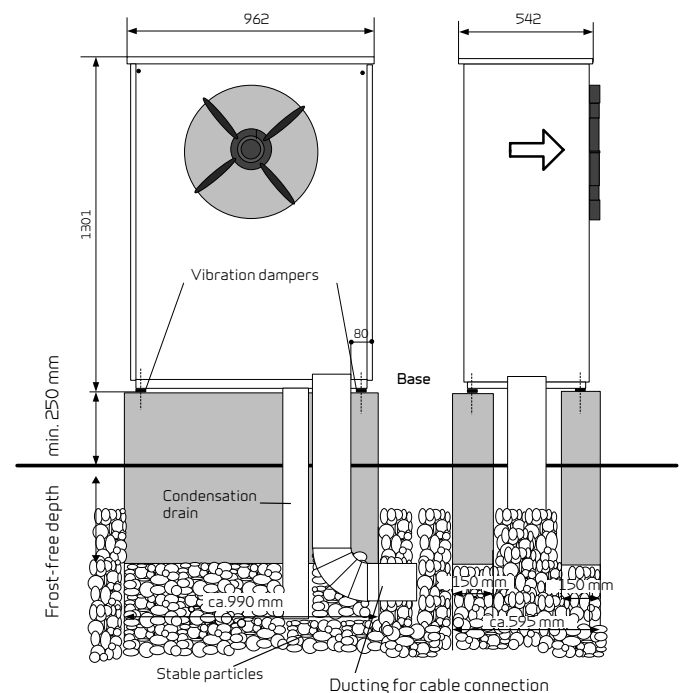

# COMPACT P GEO 3/6/9

## Product description

Compact P GEO offers the same benefits and functions as Compact P, but additionally has an integrated geothermal pump, with connection to waterborne underfloor heating or low-temperature central-heating radiators.

The heat pumps are available in two sizes: GEO 3 (0.5 - 3 kW), GEO 6 (1 - 6 kW) and GEO 9 (1,5 - 9 kW). The variable compressor makes Compact P GEO a far more efficient and energy-friendly solution than traditional heat pumps that often have compressors with a constant output.

As the output is subject to variable regulation, the heat pump never uses more energy than necessary, which gives a very high SCOP.

- With GEO 3, a SCOP of 5.17 is achieved
- With GEO 6, a SCOP of 5.15 is achieved
- With GEO 9, a SCOP of 5.49 is achieved



8-litre expansion tank for brine and the central heating circuit.

2 kW electrical completion. Ensures indoor heating in very cold periods.

Hermetically-sealed cooling circuit. Installation without the help of a refrigeration fitter.

An inverter-controlled DC compressor ensures a variable output and low energy consumption.

Integrated circulation pump for the brine circuit.

GEO 3/6/9 is controlled via the same CTS 700 touch panel as is used for Compact P.



Integrated in Compact P.

Low-noise components ensure a product that does not have an adverse impact on the surroundings.

Installed manometer and safety valve for the brine circuit. Also included for the central heating circuit.

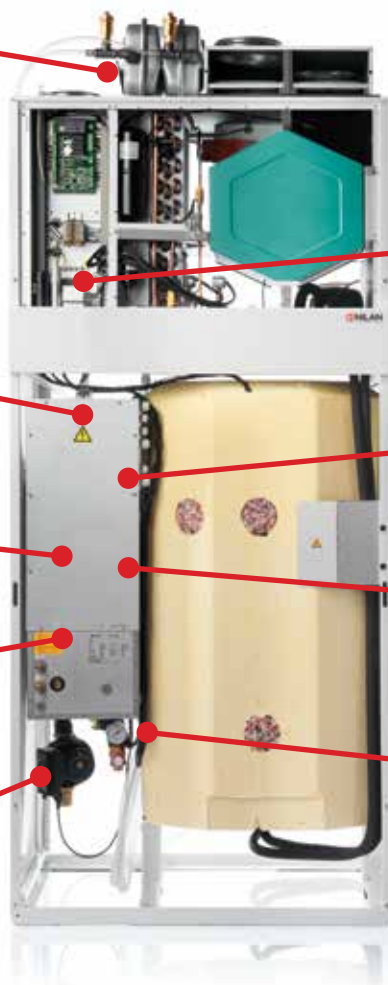



## Technical specifications

## GEO 3

## GEO 6

## GEO 9

Dimensions (W x D x H)	Integrated in Compact P 550 x 300 x 1,100 mm	Integrated in Compact P 580 x 300 x 1,100 mm	Integrated in Compact P 580 x 300 x 1,100 mm
Weight	55 kg	55 kg	56 kg
Control	CTS 700	CTS 700	CTS 700
Compressor variable speed	Yes (20-100%)	Yes (20-100%)	Yes (20-100%)
Installation site, room temperature	5°C → 35°C	5°C → 35°C	5°C → 35°C
Supply voltage and connection	400/230V 3L+N+PE, 50Hz	400/230V 3L+N+PE, 50Hz	3x400+PE, 50Hz
Fuse size	13A/20A	16A	16 A
Start current, $I_{max}$ , Start	14A	14A	15 A
Standby electricity consumption	2.5 W	2.5 W	2.5 W
Supplementary electrical heating	2 kW	2 kW	2 kW
Rated output, brine pump (max/min). A pump	87/6 W	87/6 W	87/6 W
Rated current, brine pump (max/min). A pump	0.7/0.06 A	0.7/0.06 A	0.7/0.06 A
Refrigerant	R410A	R410A	R410A
Refrigerant filling	1.1 kg	1.4 kg	1.4 kg
Pressostat low pressure (on/off)	2.2/3.4 barG	2.2/3.4 barG	2.2/3.4 barG
Pressostat high pressure (on/off)	42/33 barG	42/33 barG	42/33 barG
Antifreeze	Ethylene glycol/water Ethanol/water	Ethylene glycol/water Ethanol/water	Ethylene glycol/water Ethanol/water
Antifreeze, brine	-20°C → -18°C	-20°C → -18°C	-20°C → -18°C
Design pressure brine/central heating side	4/4 bar	4/4 bar	4/4 bar
Opening pressure safety valve brine/central heating side	3.5/2.5 bar	3.5/2.5 bar	3.5/2.5 bar
Expansion vessel brine/central heating side	8/8 litres	8/8 litres	8/8 litres
Booster expansion vessels	0.5 barG	0.5 barG	0.5 barG
Environmental pressostat brine, leak alarm (on/off)	0.6/1.1 barG	0.6/1.1 barG	0.6/1.1 barG
Heat output $P_H$ with variable compressor	0.5-3 kW	1-6 kW	1.5-9 kW
Central heating, flow temperature, operating area	25°C → 45°C	25°C → 45°C	25°C → 45°C
Brine temperature to evaporator, operating area	-5°C → 20°C	-5°C → 20°C	-5°C → 20°C
Central heating pressure loss, condenser	10 kPa/0.14 l/s	15 kPa/0.29 l/s	15 kPa/0.29 l/s
Central heating connection	3/4"	3/4"	3/4"
Brine pressure loss evaporator	10 kPa/0.19 l/s	15 kPa/0.39 l/s	15 kPa/0.39 l/s
Brine connection	1"	1"	1"
COP 0/35°C at max. $P_H$ , in accordance with EN14511:2012 with brine/water $dT=3/5$ °C*	4.5 ( $P_H$ max. 3 kW)	4.27 ( $P_H$ max. 6 kW)	4.19 ( $P_H$ max. 9 kW)
EHPA tested and approved	N/A	Yes*	
SCOP-tested in accordance with EN14825:2012**	5.17	5.15	5.49
Sound output level $L_{WA}$ at 100% heat output 0/35°C	≤ 47 dB(A)	≤ 51 dB(A)	≤ 51 dB(A)
Sound output level $L_{WA}$ at 50% heat output 0/35°C	≤ 45 dB(A)	≤ 44 dB(A)	≤ 44 dB(A)
Sound pressure level $L_{pA}$ in 1 m at 100% heat output 0/35°C	≤ 36 dB(A)	≤ 40 dB(A)	≤ 40 dB(A)
Sound pressure level $L_{pA}$ in 1 m at 50% heat output 0/35°C	≤ 34 dB(A)	≤ 33 dB(A)	≤ 33 dB(A)

\*) Complies with "EHPA Test Regulations vers. 1.4, 2011-02-01" with max. output 3 kW at 0/35°C in accordance with EN14511:2012

\*\*\*) SCOP (Seasonal COP) is for "low temperature use, average climate, defined flow"

Sound data in accordance with EN12102 and EN ISO 9614-2

# TECHNICAL PARAMETERS

## GEO 3 Heating pump system for space heating

Model	GEO 3
Air-to-water heat pump	No
Water-to-water heat pump	No
Brine-to-water heat pump	Yes
Low-temperature heat pump	Yes
Equipped with a supplementary heater	Yes
Heat pump combination heater	No
<b>Temperature control:</b>	
Model	CTS700
Class	2
Contribution to seasonal space heating energy efficiency	2%

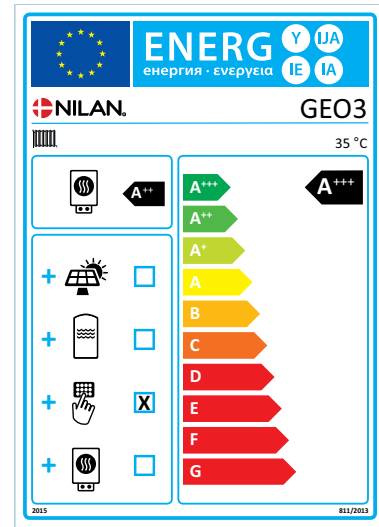

Item	Symbol	Value	Unit
------	--------	-------	------

Rated heat output	$P_{rated}$	3,44	kW
-------------------	-------------	------	----

Declared capacity for heating for part load at indoor temperature 20 °C and outdoor temperature of  $T_j$

$T_j = -7\text{ °C}$	$P_{dh}$	3,04	kW
$T_j = +2\text{ °C}$	$P_{dh}$	1,88	kW
$T_j = +7\text{ °C}$	$P_{dh}$	1,26	kW
$T_j = +12\text{ °C}$	$P_{dh}$	1,02	kW
$T_j = \text{bivalent temperature}$	$P_{dh}$	3,03	kW

$T_j = \text{operation limit temperature}$	$P_{dh}$	0	kW
For air-water-heating pumps $T_j = -15\text{ °C}$ (if TOL < $-20\text{ °C}$ )	$P_{dh}$		kW
Bivalent temperature	$T_{biv}$	-7	°C
Cycling interval capacity for heating	$P_{cyc}$		kW
Degradation co-efficient	$C_{dh}$	0,97	

Power consumption in modes other than active mode			
Off mode	$P_{OFF}$	0,003	kW
Thermostat off-mode	$P_{TO}$	0,010	kW
Standby mode	$P_{SB}$	0,010	kW
Crankcase heater mode	$P_{CK}$	0,000	kW

Other items			
Capacity control:	Variable compressor Variable indoor temperature adjustment		
	Fixed indoor water flow Fixed outdoor water flow		
Sound power level, indoors	$L_{WA}$	47	dB
Emissions of nitrogen oxides	$Q_{HE}$	931	kWh

Item	Symbol	Value	Unit
------	--------	-------	------

Seasonal space heating energy efficiency	$\eta_s$	208	%
--	----------	-----	---

Declared coefficient of performance or primary energy ratio for part load at indoor temperature 20 °C and outdoor temperature  $T_j$

$T_j = -7\text{ °C}$	$COP_d$	4,66	
$T_j = +2\text{ °C}$	$COP_d$	5,29	
$T_j = +7\text{ °C}$	$COP_d$	5,63	
$T_j = +12\text{ °C}$	$COP_d$	5,82	
$T_j = \text{bivalent temperature}$	$COP_d$	4,61	

$T_j = \text{operation limit temperature}$	$COP_d$	0	
For air-to-water heat pumps: $T_j = -15\text{ °C}$ (if TOL < $-20\text{ °C}$ )	$COP_d$		
For air-to-water heat pumps: Operation limit temperature	TOL		°C
Cycling interval efficiency	$COP_{cyc}$		
Heating water operating limit temperature	WTOL	52	°C

Supplementary heater			
Rated heat output	$P_{sup}$	2	kW
Type of energy input	Electrical		

For air-to-water heat pumps: Rated air flow rate, outdoors			$\text{m}^3/\text{h}$
For water-/brine-water heat pumps: Rated brine or water flow rate, outdoor heat exchanger		0,518	$\text{m}^3/\text{h}$

# GEO 6 Heating pump system for space heating

Model	GEO 6
Air-to-water heat pump	No
Water-to-water heat pump	No
Brine-to-water heat pump	Yes
Low-temperature heat pump	Yes
Equipped with a supplementary heater	Yes
Heat pump combination heater	No
<b>Temperature control:</b>	
Model	CTS700
Class	2
Contribution to seasonal space heating energy efficiency	2%

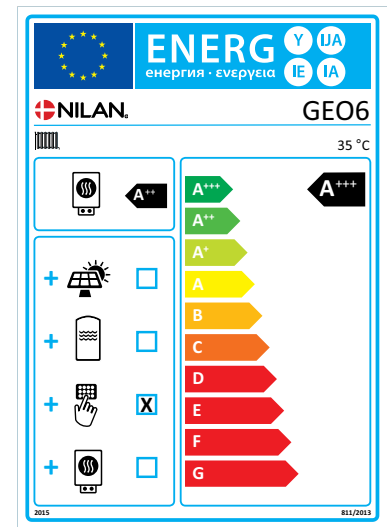

Item	Symbol	Value	Unit
Rated heat output	$P_{rated}$	6,01	kW

Declared capacity for heating for part load at indoor temperature 20 °C and outdoor temperature of  $T_j$

$T_j = -7\text{ °C}$	$P_{dh}$	5,29	kW
$T_j = +2\text{ °C}$	$P_{dh}$	3,32	kW
$T_j = +7\text{ °C}$	$P_{dh}$	2,09	kW
$T_j = +12\text{ °C}$	$P_{dh}$	1,30	kW
$T_j = \text{bivalent temperature}$	$P_{dh}$	6,01	kW

$T_j = \text{operation limit temperature}$	$P_{dh}$	0	kW
For air-water-heating pumps $T_j = -15\text{ °C}$ (if TOL < $-20\text{ °C}$ )	$P_{dh}$		kW
Bivalent temperature	$T_{biv}$	-10	°C
Cycling interval capacity for heating	$P_{cyc}$		kW
Degradation co-efficient	$C_{dh}$	0,99 - 1	

### Power consumption in modes other than active mode

Off mode	$P_{OFF}$	0,002	kW
Thermostat off-mode	$P_{TO}$	0,024	kW
Standby mode	$P_{SB}$	0,002	kW
Crankcase heater mode	$P_{CK}$	0,000	kW

### Other items

Capacity control:	Variable compressor Variable indoor temperature adjustment		
	Fixed indoor water flow Fixed outdoor water flow		
Sound power level, indoors	$L_{WA}$	51	dB
Emissions of nitrogen oxides	$Q_{HE}$	2386	kWh

Item	Symbol	Value	Unit
Seasonal space heating energy efficiency	$\eta_s$	208	%

Declared coefficient of performance or primary energy ratio for part load at indoor temperature 20 °C and outdoor temperature  $T_j$

$T_j = -7\text{ °C}$	$COP_d$	4,48	
$T_j = +2\text{ °C}$	$COP_d$	5,22	
$T_j = +7\text{ °C}$	$COP_d$	5,69	
$T_j = +12\text{ °C}$	$COP_d$	5,30	
$T_j = \text{bivalent temperature}$	$COP_d$	4,27	

$T_j = \text{operation limit temperature}$	$COP_d$	0	
For air-to-water heat pumps: $T_j = -15\text{ °C}$ (if TOL < $-20\text{ °C}$ )	$COP_d$		
For air-to-water heat pumps: Operation limit temperature	TOL		°C
Cycling interval efficiency	$COP_{cyc}$		
Heating water operating limit temperature	WTOL	?	°C

### Supplementary heater

Rated heat output	$P_{sup}$	2	kW
Type of energy input	Electrical		

For air-to-water heat pumps: Rated air flow rate, outdoors			m <sup>3</sup> /h
For water-/brine-water heat pumps: Rated brine or water flow rate, outdoor heat exchanger		1,041	m <sup>3</sup> /h

# GEO 9 Heating pump system for space heating

Model	GEO 9
Air-to-water heat pump	No
Water-to-water heat pump	No
Brine-to-water heat pump	Yes
Low-temperature heat pump	Yes
Equipped with a supplementary heater	Yes
Heat pump combination heater	No
<b>Temperature control:</b>	
Model	CTS700
Class	2
Contribution to seasonal space heating energy efficiency	2%

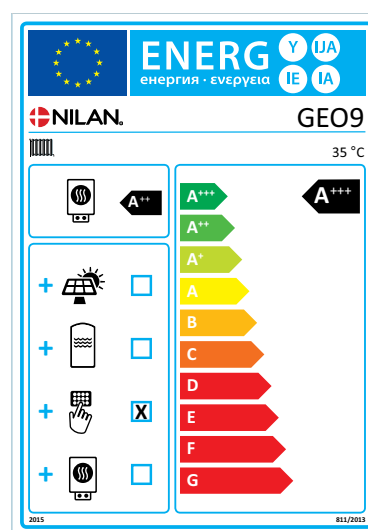

Item	Symbol	Value	Unit
------	--------	-------	------

Rated heat output	$P_{rated}$	9,05	kW
-------------------	-------------	------	----

Declared capacity for heating for part load at indoor temperature 20 °C and outdoor temperature of  $T_j$

$T_j = -7\text{ °C}$	$P_{dh}$	8,01	kW
$T_j = +2\text{ °C}$	$P_{dh}$	4,87	kW
$T_j = +7\text{ °C}$	$P_{dh}$	3,13	kW
$T_j = +12\text{ °C}$	$P_{dh}$	1,39	kW
$T_j = \text{bivalent temperature}$	$P_{dh}$	9,05	kW

$T_j = \text{operation limit temperature}$	$P_{dh}$		kW
For air-water-heating pumps $T_j = -15\text{ °C}$ (if TOL < $-20\text{ °C}$ )	$P_{dh}$		kW
Bivalent temperature	$T_{biv}$	-10	°C
Cycling interval capacity for heating	$P_{cyc}$		kW
Degradation co-efficient	$C_{dh}$	0,94-0,99	

Power consumption in modes other than active mode			
Off mode	$P_{OFF}$	0,010	kW
Thermostat off-mode	$P_{TO}$	0,015	kW
Standby mode	$P_{SB}$	0,010	kW
Crankcase heater mode	$P_{CK}$	0,010	kW

Other items			
Capacity control:	Variable compressor Variable indoor temperature adjustment		
	Fixed indoor water flow Fixed outdoor water flow		
Sound power level, indoors	$L_{WA}$		dB
Emissions of nitrogen oxides	$Q_{HE}$		kWh

Item	Symbol	Value	Unit
------	--------	-------	------

Seasonal space heating energy efficiency	$\eta_s$	232	%
--	----------	-----	---

Declared coefficient of performance or primary energy ratio for part load at indoor temperature 20 °C and outdoor temperature  $T_j$

$T_j = -7\text{ °C}$	$COP_d$	4,42	
$T_j = +2\text{ °C}$	$COP_d$	5,33	
$T_j = +7\text{ °C}$	$COP_d$	5,96	
$T_j = +12\text{ °C}$	$COP_d$	5,96	
$T_j = \text{bivalent temperature}$	$COP_d$	4,16	

$T_j = \text{operation limit temperature}$	$COP_d$		
For air-to-water heat pumps: $T_j = -15\text{ °C}$ (if TOL < $-20\text{ °C}$ )	$COP_d$		
For air-to-water heat pumps: Operation limit temperature	TOL		°C
Cycling interval efficiency	$COP_{cyc}$		
Heating water operating limit temperature	WTOL		°C

Supplementary heater			
Rated heat output	$P_{sup}$		kW
Type of energy input	Electrical		

For air-to-water heat pumps: Rated air flow rate, outdoors			$\text{m}^3/\text{h}$
For water-/brine-water heat pumps: Rated brine or water flow rate, outdoor heat exchanger		1,53	$\text{m}^3/\text{h}$

# DIMENSIONS AND FUNCTION

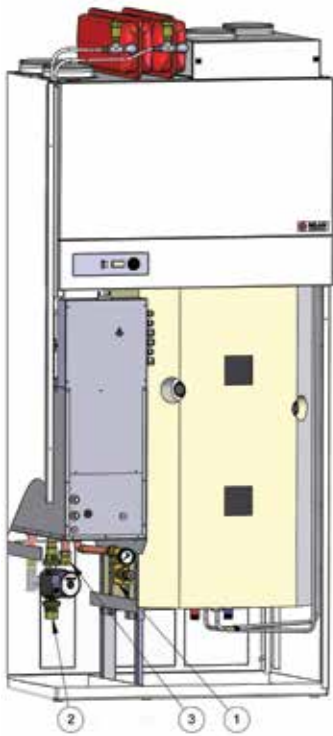

## Front

1. Return flow to brine 1"
2. Flow from brine 1"
3. Return flow, central heating 3/4"

## Base

1. Return flow to brine 1"
2. Flow from brine 1"
3. Flow from central heating 3/4"
4. Return flow central heating 3/4"

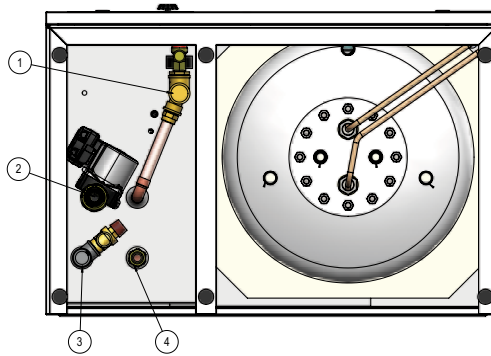

## COP - GEO 3

Tested in accordance with EN14825

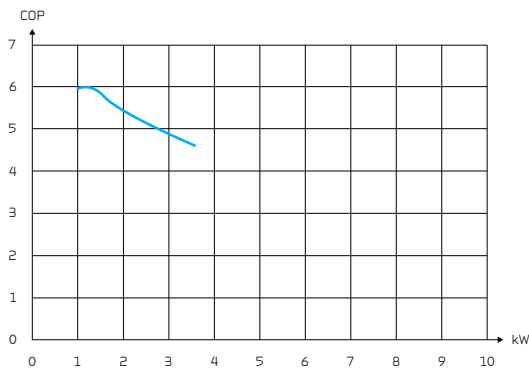

## COP - GEO 6

Tested in accordance with EN14825

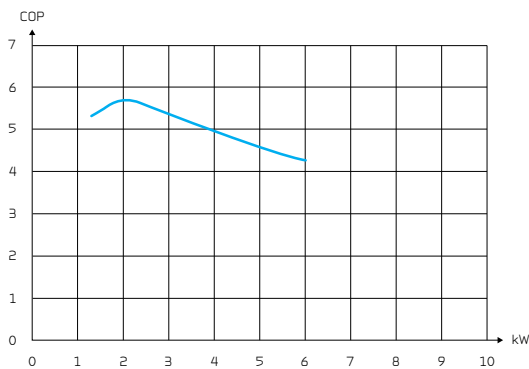

## COP - GEO 9

Tested in accordance with EN14825

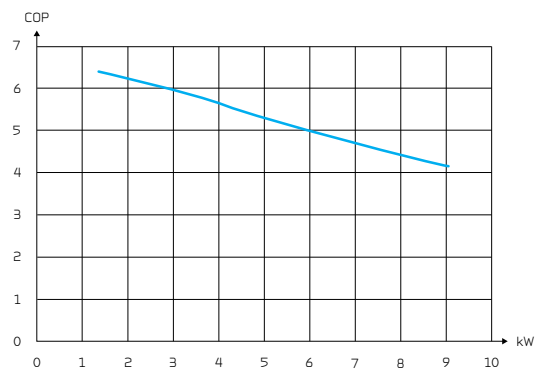

# FUNCTIONS



## Geothermal pump

GEO 3/6/9 is a geothermal pump that recovers energy from the ground to heat the home, and is not affected by periods of very cold weather. Heat is distributed in the home via Compact P for underfloor heating or low-energy radiators.

The GEO 3/6/9 interior section is integrated in the Compact P casing, giving a neat and tidy installation in the home.

The heat pump has a hermetically-sealed cooling circuit and can therefore be installed without requiring a cooling technician.

## Passive cooling

By adding an external heat exchanger, Compact P GEO 3/6/9 can also cool the home in the summer, if required.

The cold brine water is led through an external heat exchanger that cools the water in the central heating system.

## Compact P GEO

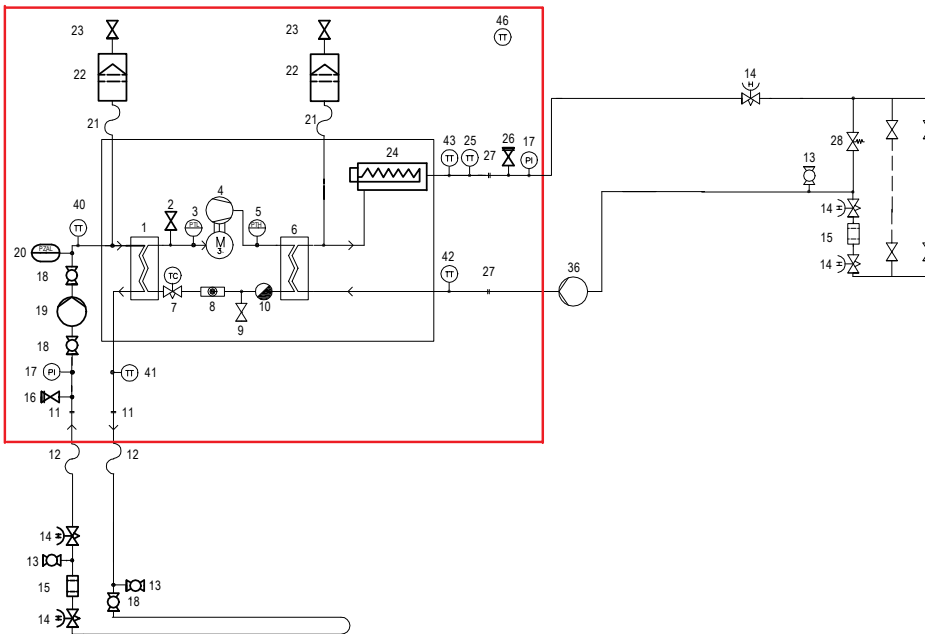

- |                                       |                                 |  |
|---------------------------------------|---------------------------------|--|
| 1 Evaporator                          | 15 Dirt filter                  | 28 Overcurrent valve                       |
| 2 Service valve for low pressure      | 16 Safety valve 3,5 bar         | 36 Circulation pump                        |
| 3 Low-pressure pressostat             | 17 Manometer                    | 40 Temperature sensor T13                  |
| 4 Compressor                          | 18 Ball valve                   | 41 Temperature sensor T14                  |
| 5 High-pressure pressostat            | 19 Circulation pump 130 mm      | 42 Temperature sensor T16                  |
| 6 Condenser                           | 20 Pressure control 0,5/1,1 bar | 43 Temperature sensor T17                  |
| 7 Expansion valve                     | 21 Flexihose 10 mm              | 46 Temperature sensor T20 (outdoor sensor) |
| 8 Sight glass with humidity indicator | 22 Expansion tank 8 L           |  |
| 9 Service valve for high pressure     | 23 Automatic control vent 3/8"  |  |
| 10 Combi filter                       | 24 Electric cartridge 2 kW      |  |
| 11 Connection 1"                      | 25 Temperature sensor T18       |  |
| 12 Flexihose 1"                       | 26 Safety valve 2,5 bar         |  |
| 13 Feed tap                           | 27 Connection 3/4"              |  |
| 14 Shut-off valve                     |                                 |  |

## SHW warmwater-tank connected to Compact P GEO

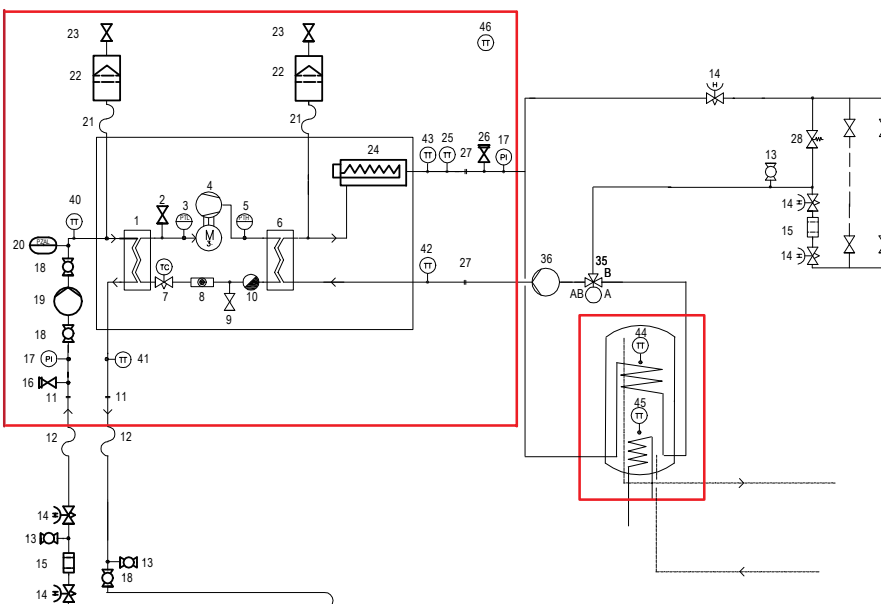

# COMPACT P SHW TANK

## Product description

The SHW tank is a 250-litre hot water tank with a built-in solar spiral and a geothermal heat pump supplementary spiral that can be connected to all Compact P solutions. The solution is ideal for families with a high consumption of hot water.

The heat pump is used to pre-heat the domestic hot water in the SHW tank to 30-45 °C (via a 3-way valve temperature sensor in the top of the SHW and the CTS 700 control).

The hot water is led in series through the SHW tank and Compact P 180-litre tank. This solution makes it possible to produce domestic hot water, since surplus heat from a heat pump and/or any solar heating system is accumulated in the tanks.

The SHW tank is prepared for the installation of a temperature sensor for external control of solar heating. The solar spiral is intended for solar heating systems with solar collectors of approx. 4 m<sup>2</sup>. The tank's foam insulation ensures minimum heat loss from the tank.



## Dimensional drawing, SHW-tank

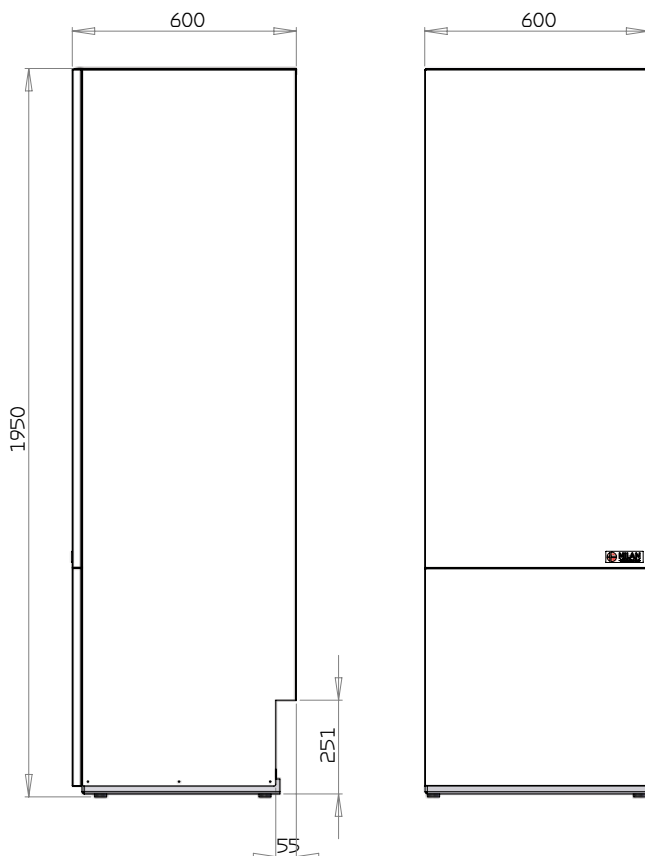

All dimensions are in mm



## Technical specifications

Dimensions (W x D x H)	600 x 600 x 1350 mm
Weight	200 kg
Plate type casing	Aluzinc steel plate, white powder coating RAL9016
Energy efficiency class	B
Standing loss	56
Volume	250 l

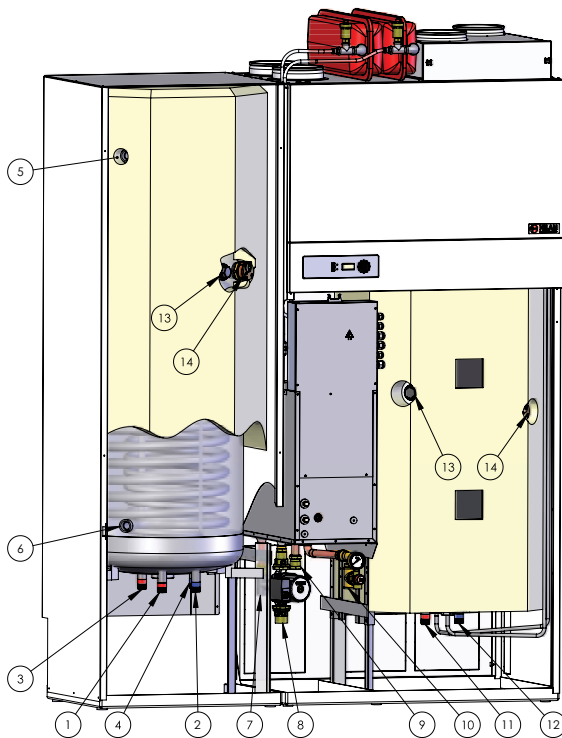
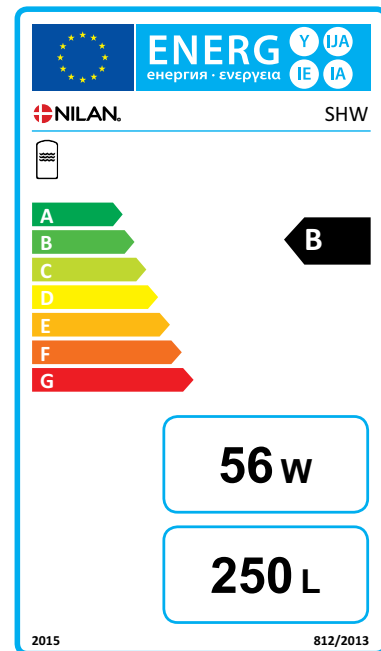

1. Hot water 3/4"
2. Cold water 3/4"
3. Flow, solar spiral 3/4"
4. Return flow, solar spiral 3/4"
5. Flow, GEO spiral 3/4"
6. Return flow, GEO spiral 3/4"
7. Flow, central heating 3/4"
8. Flow, brine 1"
9. Return flow, central heating 3/4"
10. Return flow, brine 1"
11. Hot water Compact 3/4"
12. Cold water Compact 3/4"
13. Anode 5/4"
14. Supplementary heating element 5/4"

## Tapped water

The maximum tapping volume  $V_{max}$  [L] from Compact P GEO 6 SHW as a function of tapping temperature  $t$  [°C] and tank temperature Compact Pat at 40, 50 and 60°C. Tank temperature SHW is 45°C.

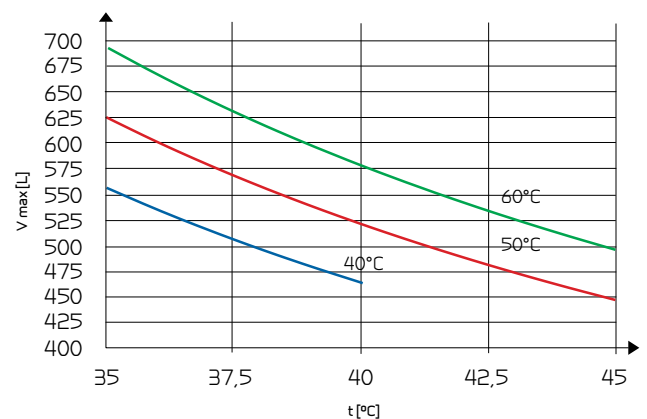

# COMPACT P EK

## Product description

The Compact P EK unit has a built-in electrical boiler that can be connected to a waterborne central heating system, thereby providing electrical heating to the home.

The advantage of Compact P EK is that it does not require buried geothermal coils, or the installation of an air extraction heat pump, which is the case for traditional heat-pump based heating solutions. This makes installation easier and less expensive.

Electrical heating is a good solution for very well-insulated homes that do not use a lot of energy for heating, such as passive buildings. However, it must be checked whether electrical heating is legally permitted.



### Compact P EK 3 kW

Heat output	3 kW
Supply voltage	230V / 3 x 230V / 3 x 400V
Max. fuse size (1 x 230 V)	16A
Max. fuse size (3 x 230 V)	13A
Max. fuse size (3 x 400V)	13A
Weight	21 kg
Standby electricity consumption	2 W
Expansion vessel	10 l

### Compact P EK 6 kW

Heat output	6 kW
Supply voltage	230V / 3 x 230V / 3 x 400V
Max. fuse size (1 x 230 V)	32A
Max. fuse size (3 x 230 V)	13A
Max. fuse size (3 x 400 V)	13A
Weight	21 kg
Standby electricity consumption	2W
Expansion vessel	10 l

### Compact P EK 9 kW

Heat output	9 kW
Supply voltage	3 x 230V / 3 x 400V
Max. fuse size (3 x 230 V)	16A
Max. fuse size (3 x 400 V)	16A
Weight	21 kg
Standby electricity consumption	2W
Expansion vessel	10 l

## Functional diagram

- 1 Connection 3/4"
- 2 Stop valve
- 3 Circulation pump
- 4 Fill valve 1/2"
- 5 Electrical kettle with electrical heating element
- 6 Pressure expansion vessel
- 7 Automatic vent
- 8 Temperature sensor
- 9 Manometer
- 10 Safety valve 2,5 bar
- 11 Particulate filter

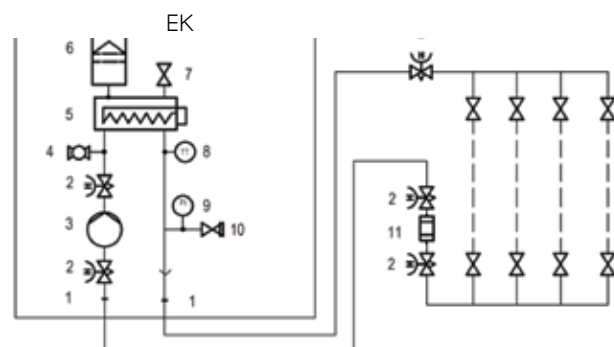

## Product description

- 1 Flow from electrical kettle 3/4"
- 2 Return flow electrical kettle 3/4"
- 3 Cold water intake 3/4"
- 4 Hot water outlet 3/4"
- 5 Sensor pouch 3/4"
- 6 Connection for circulation pipe 3/4"
- 7 Discharge air
- 8 Supply air
- 9 Outdoor air
- 10 Extract air

All dimensions are in mm

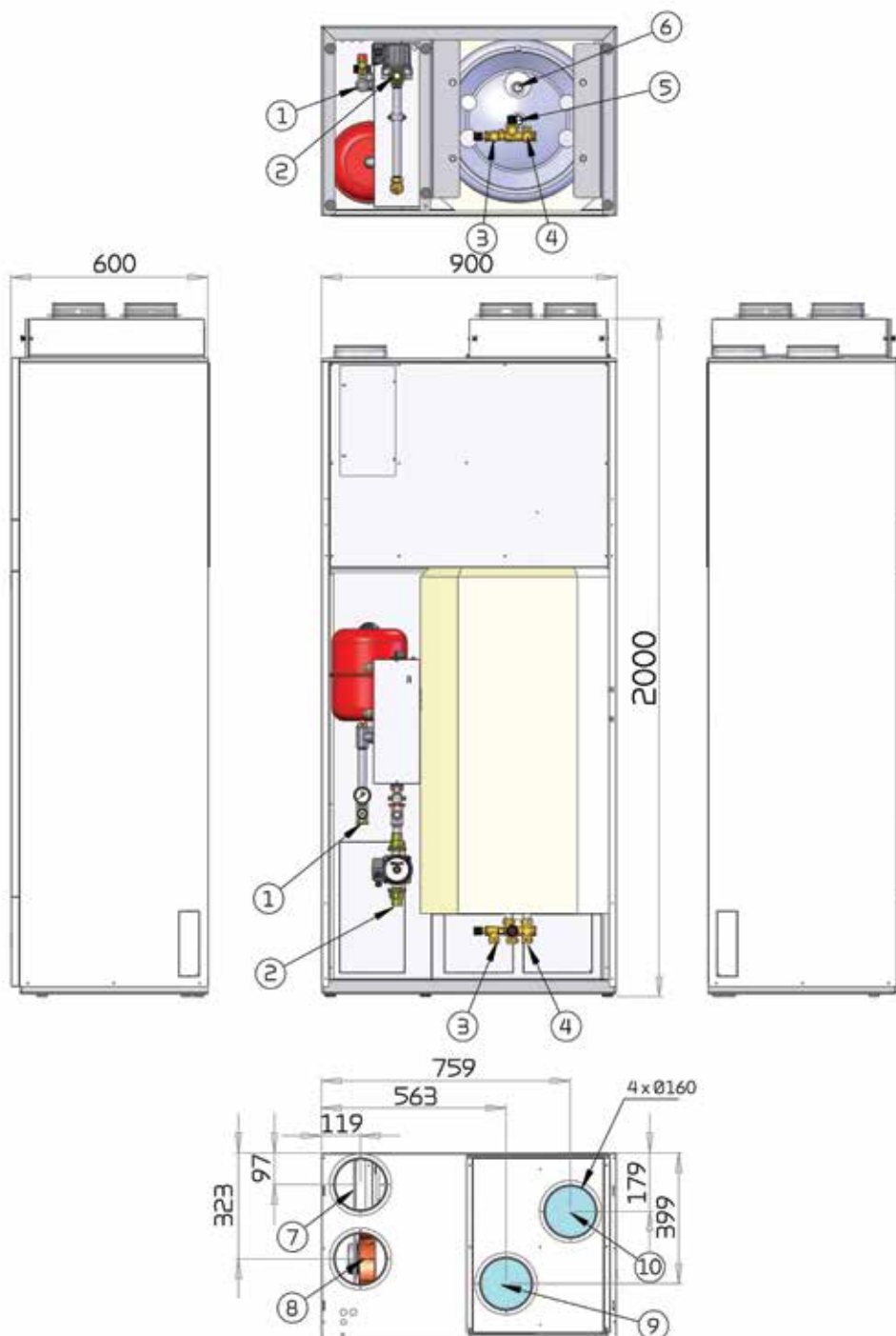

# TECHNICAL PARAMETERS EK

## Boiler system for space heating

Model	EK 3 kW
Condensing boiler	No
Low temperature boiler	No
B1 boiler	No
Cogeneration space heater	No
Combination heater	No

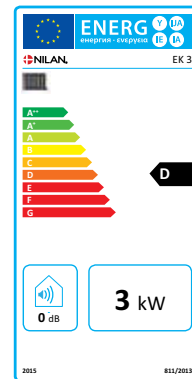

Item	Symbol	Value	Unit
Rated heat output	$P_{rated}$	2,914	kW

At rated heat output and high-temperature regime	$P_4$	2,914	kW
--	-------	-------	----

Item	Symbol	Value	Unit
Seasonal space heating energy efficiency	$\eta_s$	39	%

At rated heat output and high-temperature regime	$\eta_4$	39	%
--	----------	----	---

Other items			
Standby heat loss	$P_{stby}$	0,0864	kW

Model	EK 6 kW
Condensing boiler	No
Low temperature boiler	No
B1 boiler	No
Cogeneration space heater	No
Combination heater	No

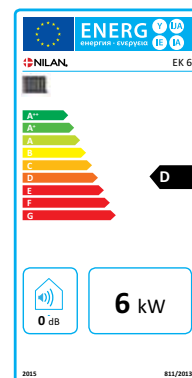

Item	Symbol	Value	Unit
Rated heat output	$P_{rated}$	5,914	kW

At rated heat output and high-temperature regime	$P_4$	5,914	kW
--	-------	-------	----

Item	Symbol	Value	Unit
Seasonal space heating energy efficiency	$\eta_s$	39	%

At rated heat output and high-temperature regime	$\eta_4$	39	%
--	----------	----	---

Other items			
Standby heat loss	$P_{stby}$	0,0864	kW

Model	EK 9 kW
Condensing boiler	No
Low temperature boiler	No
B1 boiler	No
Cogeneration space heater	No
Combination heater	No

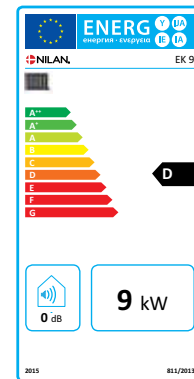

Item	Symbol	Value	Unit
Rated heat output	$P_{rated}$	8,914	kW
At rated heat output and high-temperature regime	$P_4$	8,914	kW

Item	Symbol	Value	Unit
Seasonal space heating energy efficiency	$\eta_s$	40	%
At rated heat output and high-temperature regime	$\eta_4$	40	%
Other items			
Standby heat loss	$P_{stby}$	0,0864	kW

# NILAIR

NilAIR is installed together with a ventilation unit, which in simple terms consists of distribution boxes from which tubes are led out to air extraction and air supply boxes in the individual rooms.

NilAIR can be installed in ceilings, walls or floors. The lightweight tubes can be used for even the most complicated tube alignments, where e.g. traditional spiral ducts cannot be used.

## Advantages

- Flexible and space-saving solution
- Rapid and simple installation with a click system
- Dimensionally stable and corrosion-resistant quality material
- Simple regulation of the air supply volume
- Low weight
- Airtight
- Easy to clean
- Easy to handle and transport
- Prevents sound travelling from room to room

## Air extraction

(mounted in wall or ceiling)

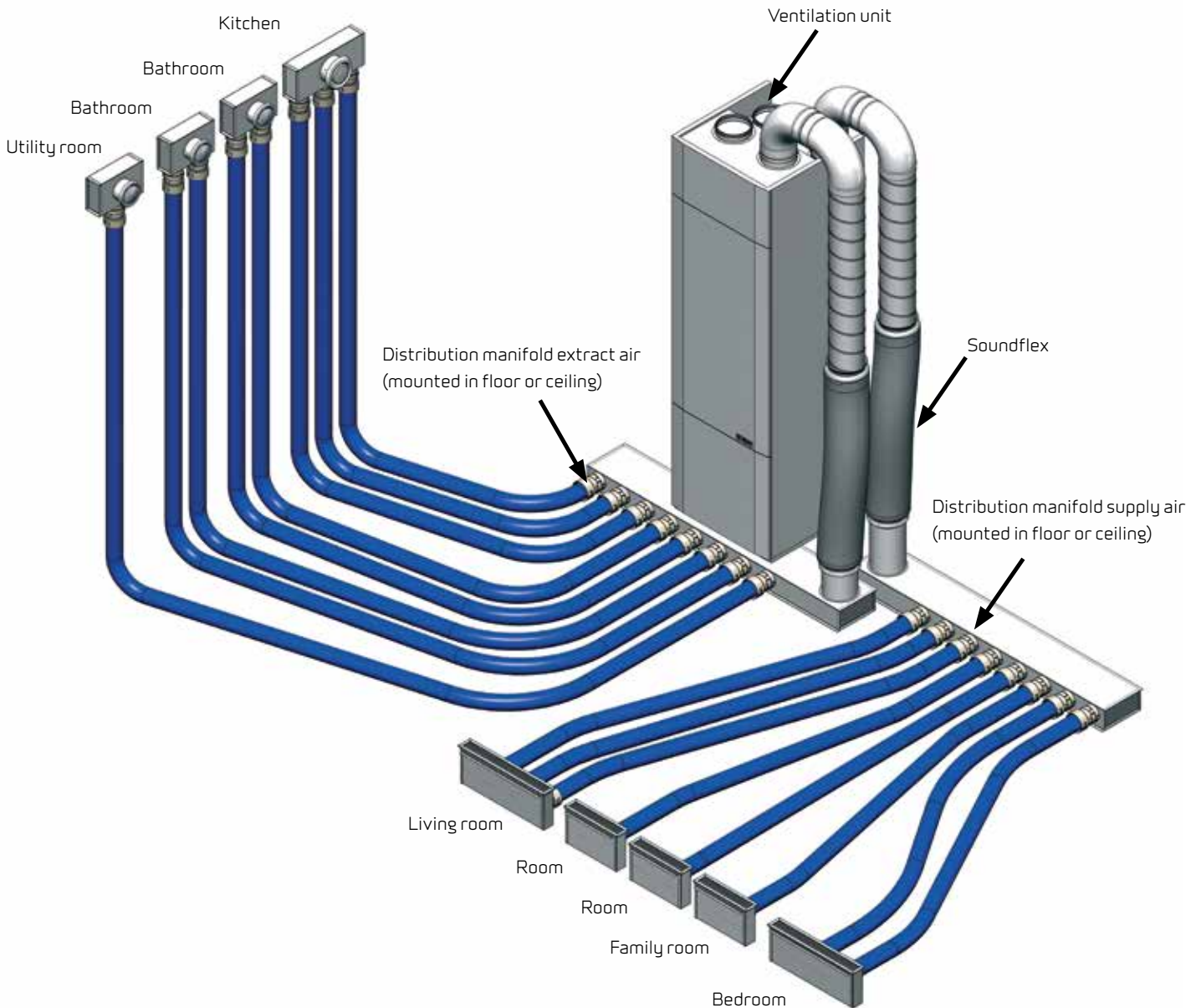

## Air supply

(mounted in floor, wall or ceiling)

Compact P is one of few compact ventilation and heat recovery units in the world to gain the internationally recognised passive building certification - in definitive recognition of the environmental benefits due to its high efficiency.

This certification means that Compact P is pre-approved for passive buildings, so that no further documentation is required.

The German Passivhaus Institut (PHI), which is behind passive building certification, is a key player in the low-energy construction industry, especially because the institute created the passive building concept.

In other words, PHI sets the standard for houses constructed as passive buildings due to their low energy consumption. The institute is thus also the trendsetter for coming EU requirements of low-energy construction.

Compact P is passive house certified via two certificates, according to efficiency and heating area. The certificates specify the following values for Compact P to certify the system's ability to provide a passive building with ventilation.

See or download the certificates at [www.nilan.dk](http://www.nilan.dk)

## Certificate

**Passive House Suitable Component**  
For cool temperate climates, valid until 31. December 2018

Category: **Compact Heat Pump System**  
Manufacturer: **Nilan A/S**  
**8722 Hedensted, DENMARK**  
Product name: **Compact P (92 m<sup>3</sup>/h)**

**This certificate was awarded based on the following criteria (limit values\*):**

Thermal Comfort:  $\theta_{\text{supply air}} \geq 16,5^{\circ}\text{C}$   
Heat Recovery of ventilation system:  $\eta_{\text{WRG,eff}} \geq 75\%$   
Electric efficiency ventilation system:  $P_{\text{el}} \leq 0,45 \text{ Wh/m}^3$   
Air tightness (internal/external):  $V_{\text{leakage}} \leq 3\%$   
Total Primary Energy Demand (\*\*):  $PE_{\text{total}} \leq 55 \text{ kWh/(m}^2\text{a)}$   
Control and calibration (\*)  
Air pollution filters (\*)  
Anti freezing strategy (\*)  
Noise emission and reduction (\*)

**Measured values to be used in PHPP (set point 92 m<sup>3</sup>/h) useful air flow rates 52 to 120 m<sup>3</sup>/h**

		Test point 1	Test point 3	Test point 3	Test point 4		
Heating	Outside Air Temperature	$T_{\text{amb}}$	-7.0	2.1	7.1	°C	
	Thermal Output Heating Heat Pump	$P_{\text{th,heat}}$	0.49	0.62	0.67	kW	
	COP number Heating Heat Pump	$COP_{\text{heat}}$	2.43	2.55	2.78	-	
	Maximum available supply air temperature with Heat Pump only(*)		33.6			°C	
Hot water	Outside Air Temperature	$T_{\text{amb}}$	-6.9	1.9	7.2	20.2	°C
	Thermal Output Heat Pump for heating up storage tank	$P_{\text{th,heat}}$	0.51	0.72	0.89	1.02	kW
	Thermal Output Heat Pump for reheating storage tank	$P_{\text{th,heat}}$	0.54	0.71	0.83	0.94	kW
	COP Heat Pump for heating up storage tank	$COP_{\text{heat}}$	2.11	2.60	3.08	3.38	-
	COP Heat Pump for reheating storage tank	$COP_{\text{heat}}$	1.94	2.50	2.80	3.05	-
	Average storage tank temperature		50.5			°C	
	Specific storage heat losses		1.63			W/K	
	Exhaust air addition (if applicable)					m <sup>3</sup> /h	

Passivhaus Institut  
Dr. Wolfgang Feist  
64283 Darmstadt  
GERMANY

**Heat Recovery**  
 $\eta_{\text{WRG,eff}} = 77\%$

**Electric efficiency**  
0.43 Wh/m<sup>3</sup>

**Air tightness**  
 $V_{\text{leak, internal}} = 1.0\%$   
 $V_{\text{leak, external}} = 1.1\%$

**Frost protection**  
down to -7 °C

**Total Primary Energy Demand (\*\*)**  
54.1 kWh/(m<sup>2</sup>a)

[www.passivehouse.com](http://www.passivehouse.com)

0390ch03

## Certificate

**Passive House Suitable Component**  
For cool temperate climates, valid until 31. December 2018

Category: **Compact Heat Pump System**  
Manufacturer: **Nilan A/S**  
**8722 Hedensted, DENMARK**  
Product name: **Compact P (172 m<sup>3</sup>/h)**

**This certificate was awarded based on the following criteria (limit values\*):**

Thermal Comfort:  $\theta_{\text{supply air}} \geq 16,5^{\circ}\text{C}$   
Heat Recovery of ventilation system:  $\eta_{\text{WRG,eff}} \geq 75\%$   
Electric efficiency ventilation system:  $P_{\text{el}} \leq 0,45 \text{ Wh/m}^3$   
Air tightness (internal/external):  $V_{\text{leakage}} \leq 3\%$   
Total Primary Energy Demand (\*\*):  $PE_{\text{total}} \leq 55 \text{ kWh/(m}^2\text{a)}$   
Control and calibration (\*)  
Air pollution filters (\*)  
Anti freezing strategy (\*)  
Noise emission and reduction (\*)

**Measured values to be used in PHPP (set point 172 m<sup>3</sup>/h) useful air flow rates 120 to 205 m<sup>3</sup>/h**

		Test point 1	Test point 3	Test point 3	Test point 4		
Heating	Outside Air Temperature	$T_{\text{amb}}$	-3.7 °C	2.0 °C	6.9 °C	°C	
	Thermal Output Heating Heat Pump	$P_{\text{th,heat}}$	0.61	0.78	0.92	kW	
	COP number Heating Heat Pump	$COP_{\text{heat}}$	2.65	3.18	3.58	-	
	Maximum available supply air temperature with Heat Pump only(*)		28.6			°C	
Hot water	Outside Air Temperature	$T_{\text{amb}}$	-4.0 °C	2.0 °C	7.0 °C	20.2 °C	°C
	Thermal Output Heat Pump for heating up storage tank	$P_{\text{th,heat}}$	0.60	0.83	0.99	1.14	kW
	Thermal Output Heat Pump for reheating storage tank	$P_{\text{th,heat}}$	0.53	0.82	0.95	1.05	kW
	COP Heat Pump for heating up storage tank	$COP_{\text{heat}}$	2.13	2.87	3.31	3.68	-
	COP Heat Pump for reheating storage tank	$COP_{\text{heat}}$	1.81	2.72	3.05	3.28	-
	Average storage tank temperature		50.5			°C	
	Specific storage heat losses		1.63			W/K	
	Exhaust air addition (if applicable)					m <sup>3</sup> /h	

Passivhaus Institut  
Dr. Wolfgang Feist  
64283 Darmstadt  
GERMANY

**Heat Recovery**  
 $\eta_{\text{WRG,eff}} = 80\%$

**Electric efficiency**  
0.40 Wh/m<sup>3</sup>

**Air tightness**  
 $V_{\text{leak, internal}} = 1.0\%$   
 $V_{\text{leak, external}} = 1.1\%$

**Frost protection**  
down to -4 °C

**Total Primary Energy Demand (\*\*)**  
51.4 kWh/(m<sup>2</sup>a)

[www.passivehouse.com](http://www.passivehouse.com)

0391ch03

47

# INFORMATION FROM A TO Z

Nilan develops and manufactures premium-quality, energy-saving ventilation and heat pump solutions that provide a healthy indoor climate and low-level energy consumption with the greatest consideration for the environment. In order to facilitate each step in the construction process - from choosing the solution through to planning, installation and maintenance - we have created a series of information material which is available for download at [www.nilan.dk](http://www.nilan.dk).



**Brochure**  
General information about the solution and its benefits.



**Product data**  
Technical information to ensure correct choice of solution.



**Installation instructions**  
Detailed guide for installation and initial adjustment of the solution.



**User manual**  
Detailed guide for regulation of the solution to ensure optimum day-to-day operation.

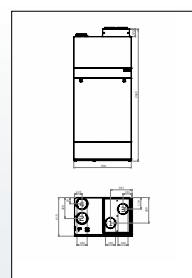

**Drawings**  
Tender documents and 3D drawings are available to download for planning purposes.

[WWW.NILAN.DK](http://WWW.NILAN.DK)

Visit us at [www.nilan.dk](http://www.nilan.dk) to find out more about our company and solutions, download further information and find your nearest dealer.



Nilan A/S  
Nilanvej 2  
8722 Hedensted  
Denmark  
Tlf. +45 76 75 25 00  
Fax +45 76 75 25 25  
[nilan@nilan.dk](mailto:nilan@nilan.dk)  
[www.nilan.dk](http://www.nilan.dk)